

COBRA 

COBRA  30

COBRA 

Prodejna PRAHA
Jeremiášova 2633/16b
155 00 Praha 13 - Stodůlky

Pracovní doba:
Po-Čt: 8:00 - 18:00
Pá: 8:00 - 16:30

Tel.: +420 235 003 107
E-mail: prodejna@cobra-cz.cz

www.matekliku.cz
www.cobrask.sk

KATALOG 2020

KATA LOG

DESIGN
KVALITA
TRADICE

ČÍSLO
30

www.MATEKLIKU.cz
www.cobrask.sk

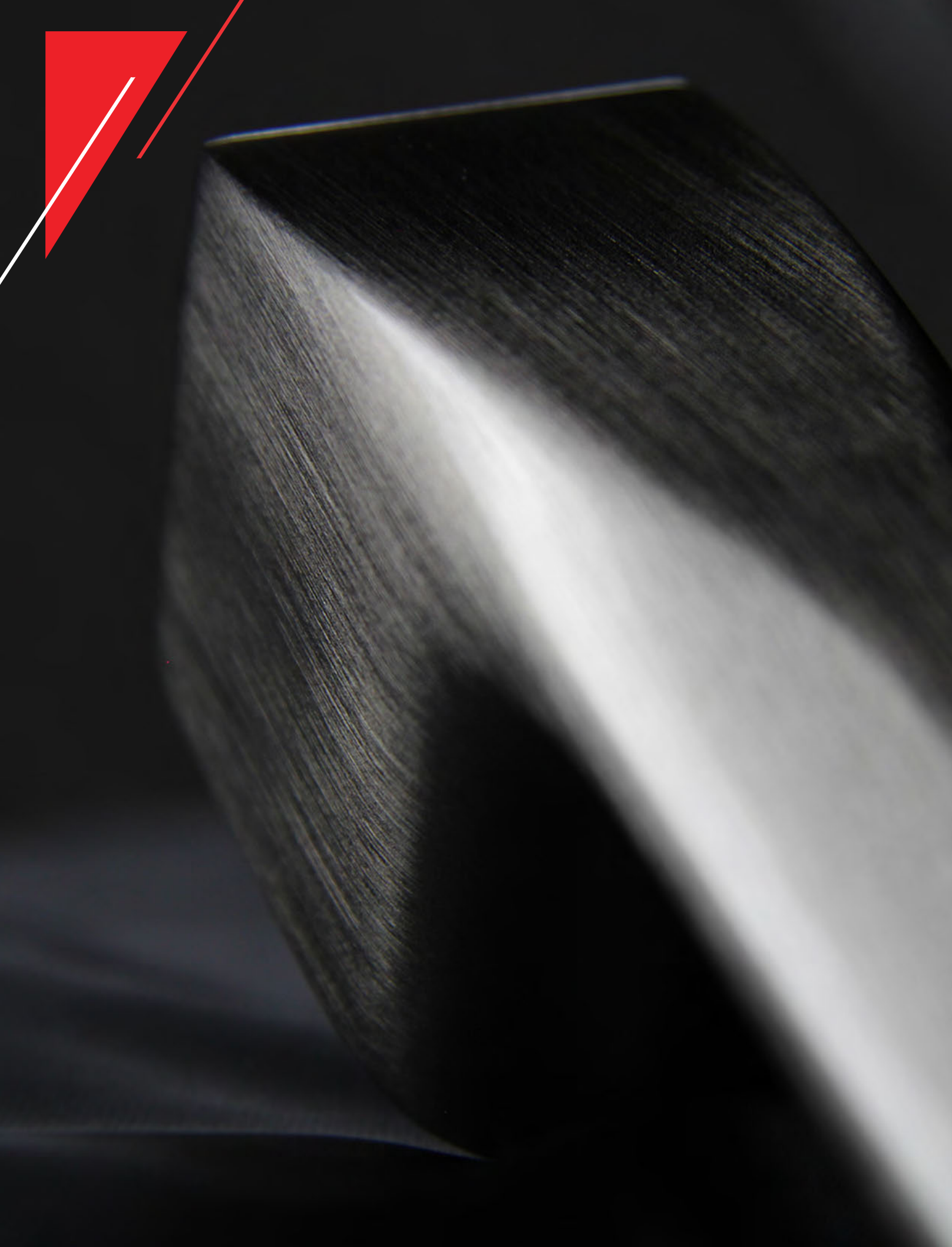

2020 PRODUKTOVÝ KATALOG

Vážení přátelé,

dovolte mi, abych vám s radostí a pýchou představila novou kolekci našich výrobků Cobra.

Číslo 2020 pro nás znamená nejen elegantní letopočet, ale hlavně rok, ve kterém oslavíme 30 let naší existence.

Už tři desítky let máme skvělou možnost pracovat ve světě jemného stavebnictví a interiérového designu - podílíme se na vybavení desítek tisíc domů, bytů a veřejných staveb, spolupracujeme s významnými architekty a designéry, jsme pyšní na spolupráci se skvělými obchodními partnery.

Ptáte se, jak se cítí třicetiletá firma? Na vrcholu sil, s dostatkem zkušeností a zároveň s ambicí dosáhnout ještě víc. Chceme se dál učit i vytvořit hodně nového, chceme pokračovat po úspěšných cestách i rozvinout nové příležitosti.

Pro katalog 30 jsme připravili nejširší nabídku dveřního a okenního kování na českém a slovenském trhu. Srdcem vybírejte design a barvu, rozumem vyberte funkčnost - druh a kombinaci nebo třeba bezpečnostní třídu. Naším cílem je v každém případě umožnit vám vybrat si právě takové kování, se kterým budete dlouhodobě spokojeni. Cobra existuje 30let díky práci svých zaměstnanců a důvěře obchodních partnerů i zákazníků. Je to pro nás ohromný závazek i radost. Věříme, že až budeme v roce 2050 představovat katalog 60, budou naše kliky, které si letos vyberete a instalujete, ještě stále krásné a funkční.

Za tým Cobra

Kristina Boda
generální ředitelka

Kristina Boda

COBRA 







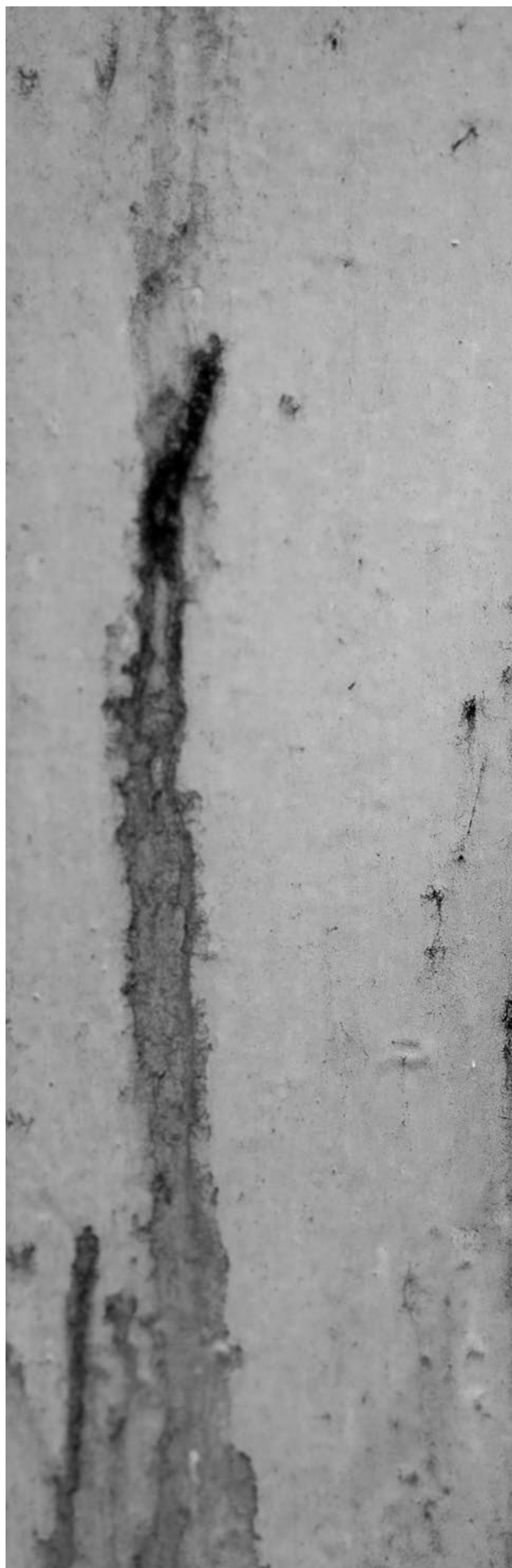









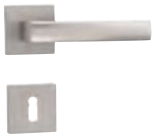















OBSAH

Úvod	1
Obsah	2
Přehled kování a doplňků	4 - 9
Průvodce katalogem	10 - 19
Kliky Premium	20 - 23
Povrch IN - Nerez Classic	24 - 31
Povrch IN - Nerez Economy	32 - 39
Povrch IN - Nerez Project	38 - 45
Povrch OCS - Chrom matný	46 - 53
Povrch OC - Chrom lesklý	54 - 57
Povrch ONS - Nikl matný	58 - 67
Povrch čená / titan	68 - 71
Povrch OCN - Chrom lesklý / nikl matný	72 - 75
Povrch OFS - Bronz česaný	76 - 81
Povrch OLV - Mosaz leštěná	82 - 85
Povrch OV - Staromosaz	86 - 87
Povrch K - kované a rustikální kování	88 - 95
BK - bezpečnostní a ochranné kování	96 - 103
S - sety	104 - 109
Povrch F1 - Stříbrný elox	110 - 113
Povrch F4 - Bronzový elox	114 - 117
Okenní kování	118 - 123
Madla / úchyty	124-133
Balkónové kliky	136
Kovaná posuvná klika Steinacht	136
Cylindrické vložky	137
Číslice a piktogramy / klepadla	138
Dorazy, stavěče, zarážky	142
Řetízky, kukátka	144
Držáky zábradlí	145
Drobný spojovací materiál	146
Krbové nářadí / Dětský program	146
Panikové kování	147
Rozety / montážní šablony	150
Prahové lišty	151
Samozavírače	151
Větrací mřížky	153
Vhozy na dopisy	153
Věšáky a konzole	154
Zadlabací zámky	156
Závěsy	157
Prodejní servis, záruky, montáž a údržba	162
Seznam kategorií	164









<p>ALENA-S</p>  <p>str.26 IN</p>	<p>ALEXIS</p>  <p>str.60 ONS</p>	<p>ALEXIS-R</p>  <p>str.60 ONS str.48 OCS</p>	<p>ALT-WIEN</p>  <p>str.87 OV str.84 OLV str.60 ONS str.90 K str.48 OCS str.78 OFS str.56 OC</p>
<p>Ochranný ALT-WIEN / ALT-WIEN+</p>  <p>str.98 OV str.98 OLV str.98 OFS</p>	<p>APHRODITE-S</p>  <p>str.60 ONS str.70 Titan</p>	<p>APOLLO+</p>  <p>str.98 černá</p>	<p>ATHENA-S</p>  <p>str.60 ONS str.70 Titan</p>
<p>ATLANTIS</p>  <p>str.90 K str.84 OLV str.78 OFS</p>	<p>ATLANTIS-R</p>  <p>str.90 K</p>	<p>BADEN</p>  <p>str.90 K</p>	<p>BADEN+</p>  <p>str.90 K</p>
<p>BADEN-S</p>  <p>str.90 K</p>	<p>BADEN-S+</p>  <p>str.91 K</p>	<p>BEATA-S</p>  <p>str.60 ONS</p>	<p>BERLIN</p>  <p>str.91 K</p>
<p>BIANCA-R</p>  <p>str.26 IN</p>	<p>BREMEN</p>  <p>str.91 K</p>	<p>BRUG</p>  <p>str.91 K</p>	<p>BRUG-R</p>  <p>str.91 K</p>
<p>C101+</p>  <p>str.98 ONS str.98 OFS</p>	<p>C201</p>  <p>str.98 ONS str.98 OFS</p>	<p>C301</p>  <p>str.98 ONS str.98 OFS</p>	<p>C501+</p>  <p>str.99 IN</p>
<p>DEA</p>  <p>str.78 OFS</p>	<p>DEA-R</p>  <p>str.78 OFS</p>	<p>DENISA</p>  <p>str.61 ONS</p>	<p>DENISA-R</p>  <p>str.61 ONS</p>
<p>DIANA-R+</p>  <p>str.99 F9 str.99 F4 str.99 F1</p>	<p>DIVA-R III</p>  <p>str.34 IN</p>	<p>ELEGANT</p>  <p>str.87 OV str.84 OLV str.61 ONS str.48 OCS str.56 OC str.91 K str.78 OFS</p>	<p>ELEGANT+</p>  <p>str.99 OV str.99 OLV str.99 OFS</p>

<p>ELEMENT</p>  <p>str. 61 F9 str. 61 F4 str. 61 ONS</p>	<p>ELEMENT-R</p>  <p>str. 61 ONS</p>	<p>ELSA-S</p>  <p>str. 61 ONS str. 48 OCS</p>	<p>ESME-S</p>  <p>str. 62 ONS str. 48 OCS</p>
<p>FAP</p>  <p>str. 62 ONS</p>	<p>FAP-R</p>  <p>str. 62 ONS</p>	<p>FLORENCE</p>  <p>str. 78 OFS</p>	<p>GABRI</p>  <p>str. 74 OCN</p>
<p>GABRI-R</p>  <p>str. 74 OCN</p>	<p>GABRI-S</p>  <p>str. 74 OCN</p>	<p>GIUSSY</p>  <p>str. 26 IN</p>	<p>GIUSSY-R</p>  <p>str. 74 OCN str. 79 OFS str. 26 IN</p>
<p>GIUSSY-S</p>  <p>str. 26 IN</p>	<p>Giussy-R III</p>  <p>str. 36 IN</p>	<p>Giussy-S III</p>  <p>str. 34 IN</p>	<p>HAMBURG</p>  <p>str. 92 K</p>
<p>HAMBURG-R</p>  <p>str. 92 K</p>	<p>HAMBURG-R+</p>  <p>str. 92 K</p>	<p>IKARUS</p>  <p>str. 84 OLV str. 79 OFS</p>	<p>IMST+</p>  <p>str. 92 K</p>
<p>IMST-R</p>  <p>str. 92 K</p>	<p>INFINITY</p>  <p>str. 21 ONS str. 21 Černá</p>	<p>INNSBRUCK</p>  <p>str. 92 K</p>	<p>INNSBRUCK-R</p>  <p>str. 93 K</p>
<p>IRIS-R III</p>  <p>str. 34 IN</p>	<p>IRIS-S III</p>  <p>str. 34 IN</p>	<p>JEROME-R</p>  <p>str. 49 OCS</p>	<p>KANELAZ 1745</p>  <p>str. 22 OS str. 22 MB str. 22 ONS</p>
<p>KOULE PEVNÁ BONN</p>  <p>str. 94 K</p>	<p>KOULE PEVNÁ LINZ</p>  <p>str. 94 K</p>	<p>KOULE PEVNÁ LUNA</p>  <p>str. 31 IN</p>	<p>KOULE PEVNÁ STAR</p>  <p>str. 31 IN</p>

<p>KOULE PEVNÁ STELLA</p>  <p>str.31 IN</p>	<p>KOULE PEVNÁ VICTORY</p>  <p>str.75 OCN str.81 OFS str.66 ONS str.52 OCS</p>	<p>KRISTINA</p>  <p>str.84 OLV str.79 OFS</p>	<p>KRISTINA-R</p>  <p>str.84 OLV str.79 OFS</p>
<p>LAURA</p>  <p>str.79 OFS str.85 OLV str.62 ONS str.49 OCS str.56 OC</p>	<p>LAURA-R</p>  <p>str.79 OFS str.85 OLV str.62 ONS str.49 OCS str.56 OC</p>	<p>LINDA-S</p>  <p>str.70 Černá</p>	<p>LOFT</p>  <p>str.26 IN str.41 IN</p>
<p>LOFT KRÁTKÝ ŠTÍT</p>  <p>str.41 IN</p>	<p>LOFT OVÁL</p>  <p>str.41 IN</p>	<p>LOFT-R</p>  <p>str.27 IN str.41 IN</p>	<p>LOFT-R III</p>  <p>str.34 IN</p>
<p>LOFT-R OVÁL</p>  <p>str.27 IN</p>	<p>MAJA</p>  <p>str.62 ONS</p>	<p>MARS-S+</p>  <p>str.99 F1 str.99 Černá</p>	<p>MEGA-R</p>  <p>str.49 OCS</p>
<p>MEGA-S</p>  <p>str.49 OCS</p>	<p>MILENA</p>  <p>str.80 OFS str.63 ONS str.49 OCS</p>	<p>MILENA-R</p>  <p>str.63 ONS str.50 OCS</p>	<p>MONET</p>  <p>str.116 F4 str.112 F1</p>
<p>MONET-R</p>  <p>str.116 F4 str.112 F1</p>	<p>MÜNSTER</p>  <p>str.85 OLV str.80 OFS</p>	<p>NICOL-R</p>  <p>str.74 OCN</p>	<p>NICOL-S</p>  <p>str.74 OCN</p>
<p>NOVA-S</p>  <p>str.27 IN</p>	<p>ORION</p>  <p>str.63 ONS str.50 OCS</p>	<p>ORION-R</p>  <p>str.56 OC str.63 ONS str.50 OCS</p>	<p>ORION-R III</p>  <p>str.63 ONS</p>
<p>PAOLA</p> 	<p>PAOLA-R</p> 	<p>PAOLA-R III</p>  <p>str.35 IN</p>	<p>PAVLA-H</p>  <p>str.28 IN</p>

<p>PAVLA-R III</p>  <p>str. 35 IN</p>	<p>PAVLA-S</p>  <p>str. 27 IN</p>	<p>PAVLA-S III</p>  <p>str. 35 IN</p>	<p>PLAZA</p>  <p>str. 28 IN</p>
<p>PLAZA-H</p>  <p>str. 28 IN</p>	<p>PLAZA-R</p>  <p>str. 28 IN</p>	<p>PLAZA-S</p>  <p>str. 28 IN</p>	<p>PRESSO-S</p>  <p>str. 50 OCS str. 63 ONS</p>
<p>PŘÍDAVNÁ ROZETA HRANATÁ</p>  <p>str. 102 OLV str. 102 IN</p>	<p>PŘÍDAVNÁ ROZETA OVÁLNÁ</p>  <p>str. 102 OLV str. 102 IN</p>	<p>PŘÍDAVNÁ ROZETA KULATÁ</p>  <p>str. 102 OLV str. 102 IN</p>	<p>Q-ARTE</p>  <p>str. 64 ONS str. 50 OCS</p>
<p>Q-ARTE-S</p>  <p>str. 64 ONS str. 50 OCS</p>	<p>REGEN</p>  <p>str. 93 K</p>	<p>ROZETA TOWER</p>  <p>str. 102 F9 str. 102 F4 str. 102 F1</p>	<p>SALI</p>  <p>str. 28 IN</p>
<p>SALI-R</p>  <p>str. 29 IN</p>	<p>SALI-R III</p>  <p>str. 35 IN</p>	<p>SALI-S</p>  <p>str. 29 IN</p>	<p>SALZBURG</p>  <p>str. 93 K</p>
<p>SALZBURG-S</p>  <p>str. 93 K</p>	<p>SHARON-R / SHARON-S</p>  <p>str. 75 OCN</p>	<p>SINA</p>  <p>str. 80 OFS str. 64 ONS</p>	<p>SINA-R</p>  <p>str. 80 OFS str. 64 ONS</p>
<p>SLIM-2</p>  <p>str. 100 F9 str. 100 F4 str. 100 F1</p>	<p>SPECTRA</p>  <p>str. 21 Černá str. 21 ONS</p>	<p>SPRING-S</p>  <p>str. 64 ONS str. 48 OCS</p>	<p>SVEVA</p>  <p>str. 100 OLV str. 100 OFS str. 100 ONS str. 100 OC</p>
<p>SVEVA+</p>  <p>str. 100 OLV str. 100 OFS str. 100 ONS str. 100 OC</p>	<p>TITAN</p>  <p>str. 100 OLV str. 100 OFS str. 100 ONS str. 100 OC</p>	<p>TITAN+</p>  <p>str. 100 OLV str. 100 OFS str. 100 ONS str. 100 OC</p>	<p>TOWER</p>  <p>str. 101 F9 str. 101 F4 str. 101 F1</p>

<p>TOWER+</p>  <p>str. 101 F9 str. 101 F4 str. 101 F1</p>	<p>TOWER-H</p>  <p>str. 101 F9 str. 101 F4 str. 101 F1</p>	<p>UFO</p>  <p>str. 29 IN str. 43 IN</p>	<p>UFO KRÁTKÁ ŠTÍT</p>  <p>str. 43 IN</p>
<p>UFO SLIM</p>  <p>str. 29 IN</p>	<p>UFO OVÁL</p>  <p>str. 43 IN</p>	<p>UFO-R</p>  <p>str. 29 IN str. 43 IN</p>	<p>UFO-R III</p>  <p>str. 35 IN</p>
<p>UFO-R OVÁL</p>  <p>str. 29 IN</p>	<p>ULTIMA</p>  <p>str. 21 ONS str. 21 Černá</p>	<p>UNIVERSAL</p>  <p>str. 116 F4 str. 112 F1</p>	<p>UNIVERSAL-R</p>  <p>str. 116 F4 str. 112 F1</p>
<p>VANDA-R</p>  <p>str. 75 OCN</p>	<p>VEGA-S</p>  <p>str. 64 ONS str. 70 Černá</p>	<p>VENEZIA</p>  <p>str. 80 OFS str. 93 K</p>	<p>VENEZIA-R</p>  <p>str. 93 K</p>
<p>VERA-S</p>  <p>str. 70 Černá str. 80 OFS str. 65 ONS</p>	<p>VIENNA-R+</p>  <p>str. 94 K</p>	<p>VISION</p>  <p>str. 30 IN str. 45 IN</p>	<p>VISION KRÁTKÝ ŠTÍT</p>  <p>str. 45 IN</p>
<p>VISION OVÁL</p>  <p>str. 45 IN</p>	<p>VISION-R</p>  <p>str. 30 IN str. 45 IN</p>	<p>VISION-R III</p>  <p>str. 70 Černá str. 36 IN</p>	<p>VISION-R OVÁL</p>  <p>str. 30 IN</p>
<p>VISION-R PLOCHÁ ROZETA</p>  <p>str. 30 IN</p>	<p>VISION-S</p>  <p>str. 30 IN</p>	<p>VISION-S III</p>  <p>str. 36 IN</p>	<p>VISION-S PLOCHÁ ROZETA</p>  <p>str. 30 IN</p>
<p>ZEUS</p>  <p>str. 65 ONS</p>	<p>ZEUS-R III</p>  <p>str. 65 ONS</p>	<p>ZOE-R</p>  <p>str. 71 Černá str. 31 IN str. 81 OFS str. 65 ONS</p>	<p>865</p>  <p>str. 71 Černá str. 51 OCS str. 65 ONS</p>





<p>1145</p>  <p>str.51 OCS str.65 ONS</p>	<p>1485</p>  <p>str.51 OCS str.56 OC</p>	<p>1495</p>  <p>str.66 ONS str.51 OCS str.57 OC</p>	<p>1505</p>  <p>str.52 OCS str.57 OC</p>
--	---	---	---

<p>1515</p>  <p>str.51 OCS str.57 OC</p>	<p>1535</p>  <p>str.66 ONS str.52 OCS</p>	<p>1555</p>  <p>str.71 Černá str.66 ONS str.51 OCS</p>
---	--	--

**PŘEHLED KOVÁNÍ
A DOPLŇKŮ**

<p>OKENNÍ KOVÁNÍ</p>  <p>str.118</p>	<p>MADLA / ÚCHYTY</p>  <p>str.124</p>	<p>BALKÓNOVÉ KLIKY</p>  <p>str.136</p>
---	---	---

<p>KOVANÁ POSUVNÁ KLIKA STEINACHT</p>  <p>str.137</p>	<p>CYLINDRICKÉ VLOŽKY</p>  <p>str.138</p>	<p>ČÍSLICE A PIKTOGRAMY / KLEPADLA</p>  <p>str.142</p>	<p>DORAZY, STAVĚČE, ZARÁŽKY</p>  <p>str.144</p>
---	---	---	---

<p>ŘETÍZKY, KUKÁTKA</p>  <p>str.145</p>	<p>DRŽÁKY ZÁBRADLÍ</p>  <p>str.146</p>	<p>DROBNÝ SPOJOVACÍ MATERIÁL</p>  <p>str.146</p>	<p>KRBOVÉ NÁŘADÍ / DĚTSKÝ PROGRAM</p>  <p>str.147</p>
--	---	--	--

<p>PANIKOVÉ KOVÁNÍ</p>  <p>str.148</p>	<p>ROZETY / MONTÁŽNÍ ŠABLONY</p>  <p>str.150</p>	<p>PRÁHOVÉ LIŠTY</p>  <p>str.151</p>	<p>SAMOZAVÍRAČE</p>  <p>str.152</p>
---	---	--	--

<p>VĚTRACÍ MŘÍŽKY</p>  <p>str.153</p>	<p>VHOZY NA DOPISY</p>  <p>str.153</p>	<p>VĚŠÁKY A KONZOLE</p>  <p>str.154</p>	<p>ZADLABACÍ ZÁMKY</p>  <p>str.156</p>
--	---	---	---

ZÁVĚSY

















str.157

Symbols / Symbols

 Objektové kování Hardware for object	 KR Kovová rozeta Metal rosette	 Ochranné kování Protective fitting
 Kuličkové ložisko Ball-bearing	 BV Bez výstupků Without pins	 1 Bezpečnostní certifikát 1. třída bezpečnosti dle ČSN EN 1906 Safety certificate - The first class of safety
 Protipožární Fireproof	 PR Plastová rozeta Plastic rosette	 2 Bezpečnostní certifikát 2. třída bezpečnosti dle ČSN EN 1906 Safety certificate - The second class of safety
 Kovová vratná pružina Metal spring	 00 Prověřený způsob uchycení Proven assembling	 3 Bezpečnostní certifikát 3. třída bezpečnosti dle ČSN EN 1906 Safety certificate - The third class of safety
 Fixační kovové výstupky Fixing metal pins	 100 tis. 100 tis. frekvence použití, certifikováno na minimální počet cyklů Frequency of use - min. 100 thousand	 4 Bezpečnostní certifikát 4. třída bezpečnosti dle ČSN EN 1906 Safety certificate - The fourth class of safety
 Venkovní použití Outdoor use	 200 tis. 200 tis. frekvence použití, certifikováno na minimální počet cyklů Frequency of use - min. 200 thousand	 BB - dőzický klíč Standard keyhole
 OK Set, možnost sestavy vchodové, okenní, dveřní Set, possibility of set - entrance, window, door	 1 mil. 1 mil. frekvence použití, certifikováno na minimální počet cyklů Frequency of use - min. 1 milion	 Koule/klika Knob/handle
		 PZ - Cylindrická vložka Profile cylinder

Tabulka povrchů kování

List of possible finishes for door handles

 IN Nerez Matt Stanielss steel	 OCN Chrom lesk / Nikl mat Polished chrome / satin nickel	 OS Matná mosaz Matt brass	 F4 Bronzový elox Brass elox
 OCS Chrom matný Satin chrome	 OFS Bronz česaný Brushed brass	 MB Matný bronz Matt bronze	 Černá Černá Black
 OC Chrom lesklý Polished chrome	 OLV Mosaz leštěná Polished brass	 K Kované a rustikální Forged hardware	 Titan Titan Titanium
 ONS Nikl matný Satin nickel	 OV Staromosaz Old brass	 F1 Stříbrný elox Silver elox	

Můžete investovat mnoho času i peněz do volby podlah, oken nebo třeba kuchyňské linky a bude to úplně v pořádku. Šperkem, který zvýrazní styl vaší domácnosti, se ale mohou stát právě kliky a kování na vašich dveřích. Nejde totiž jen o funkční prostředek k otevírání dveří - při správné volbě skutečně plní funkci estetického doplňku, kterého se každodenně dotýkáme, vnímáme ho, a který by měl respektovat osobitost a design našeho bytu či domu.

You can surely invest plenty of time and money in the right choice of floorboards, windows or even a kitchen line and it will be perfectly fine. However, the gem that may enhance your household style can simply be the right choice of door handles and fittings. It is not just functional device to open doors, but also - if appropriately selected - it can undoubtedly perform the function of an aesthetic accessory which we touch and perceive on daily basis. It should therefore respect the distinctiveness and the design of our flat or house.

Zeus







název kliky / model

200 tis.

piktogramy vlastností dané kliky na straně 3 - SYMBOLY / pictograms of characteristics of a selected model shown on page 3 - SYMBOLS

piktogram tvaru zvolené vložky - kompletní seznam na straně 3 / Pictogram of a selected keyhole - complete list on page 3

ceny v českých korunách bez DPH a s 21% DPH / Prices in Czech crowns without VAT and with 21% VAT

	CZK	bez DPH	s DPH
 BB/PZ		355,-	430,-
 WC		455,-	550,-
 PZ-LI/RE		500,-	605,-
	EUR	bez DPH	s DPH
 BB/PZ		13,9	16,7
 WC		17,8	21,4
 PZ-LI/RE		19,6	23,5

ceny v eurech bez DPH a s 20% DPH / Prices in Euros without VAT and with 20% VAT

výška štítu / length of plate

237

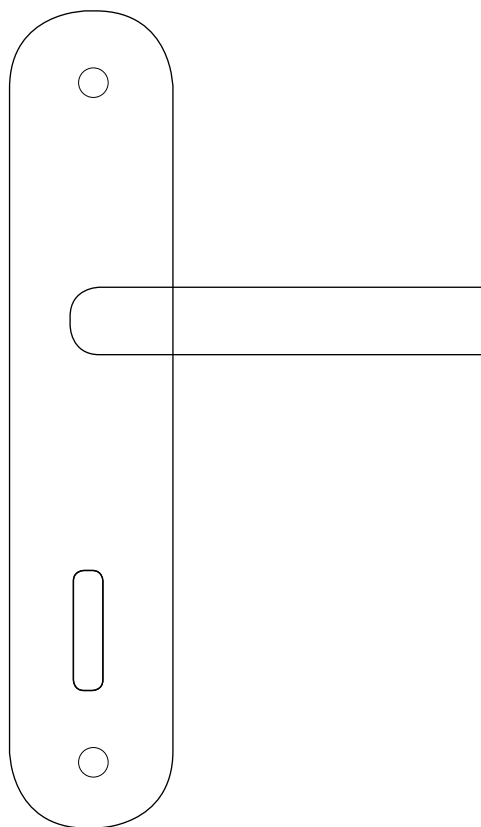

40 — šířka štítu, rozety / width of plate, rosette

šířka kliky / width of handle — 115 —

59 — celková hloubka (štít včetně kliky) / total depth (including the handle)



fotografie kliky v daném povrchu / picture of a chosen door handle in the given finish

ONS

piktogramy s možností povrchu této dané kliky - zkratky povrchů naleznete na straně 4 / pictograms of possible finishes for a chosen handle - complete list of finishes shown on page 4

- Výše DPH se řídí platnými předpisy pro danou zemi
- Products are listed with the current VAT of 21% in CZK and 20% in EUR and are subject to change. Current prices with VAT are available at www.matekliku.cz

JAK VYBRAT TO SPRÁVNÉ KOVÁNÍ?

Nabídka dveřních kování, jednotlivých tvarů, kombinací a designů je tak široká, že na první pohled může být složité se v ní zorientovat. Rozhodnutí o designu záleží pouze na vás, my vám rádi pomůžeme vybrat to správné řešení z pohledu technických parametrů:

1. DRUH KOVÁNÍ

Jaký styl se více hodí na vaše dveře - rozetové nebo štítové kování?

ROZETOVÉ - skládá se ze dvou dílů - samostatné kliky a rozety pro zámek.

- Elegantní a moderní typ kování oblíbený zejména v moderních interiérech a kancelářích
- Vnitřní systém prošroubování zajišťuje dlouhou životnost kování, montážní šrouby jsou překryty rozetami, díky čemuž vypadá rozetové kování vždy elegantně
- Kromě designu samotné kliky rozhodujeme zpravidla i o tvaru rozety - mezi kulatou, oválnou a hranatou

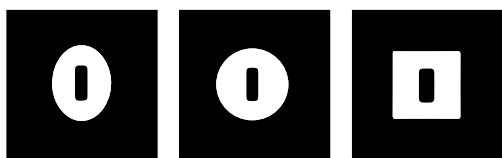

ŠTÍTOVÉ - jedná se o jednoduché dveřní kování, kde je otvor pro zámek i kliku zakrytý jedním štítem.

- Snadné na montáž pomocí viditelných vrtulů
- Nejběžnější a nejdéle používaný typ kování, který najde své místo ve všech interiérech, od bytů po chaty a zahradní domky.

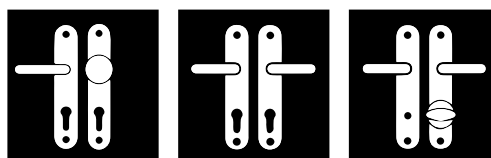

2. DRUH ZÁMKU

Varianta zámku a klíče pochopitelně odpovídá konkrétnímu umístění dveřního kování. V našem katalogu a eshopu se běžně setkáte s následujícími označeními:

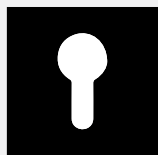

PZ - zkratka pro klíč se zámekem, takzvanou „fabkou“



BB - součástí kování je otvor pro klasický dózický klíč.



WC - sada využívaná na toaletách a v koupelnách - z vnitřní strany dveří je pro zamčení opatřena WC klikkou, ze strany vnější je rozeta s drážkou, díky které lze v případě potřeby dveře odemknout z vnější strany použitím plochého předmětu.

3. KOMBINACE KOVÁNÍ

Ne všechny dveře vyžadují kliku. Jakou kombinaci dveřního kování opravdu potřebujete?



Klika klika



Klika koule

3. ORIENTACE KOVÁNÍ

Rozhodnutí, zda objednáte levou nebo pravou kliku, je jedna z mála věcí, které musíte stanovit samostatně a dobře. Pro rozhodnutí je jednoduchá poučka - pokud na kliku sáhnete pravou rukou, jedná se o kliku pravou. Stejně tak levou kliku budete vždy otvírat rukou levou. Pokud dokážete otvírat pravou rukou levou kliku, děláte to špatně nebo stojíte zády ke dveřím. Abychom dostáli instruktážním zásadám, raději ještě uvedeme upřesňující grafiky, které vám jistě pomohou nejlépe:

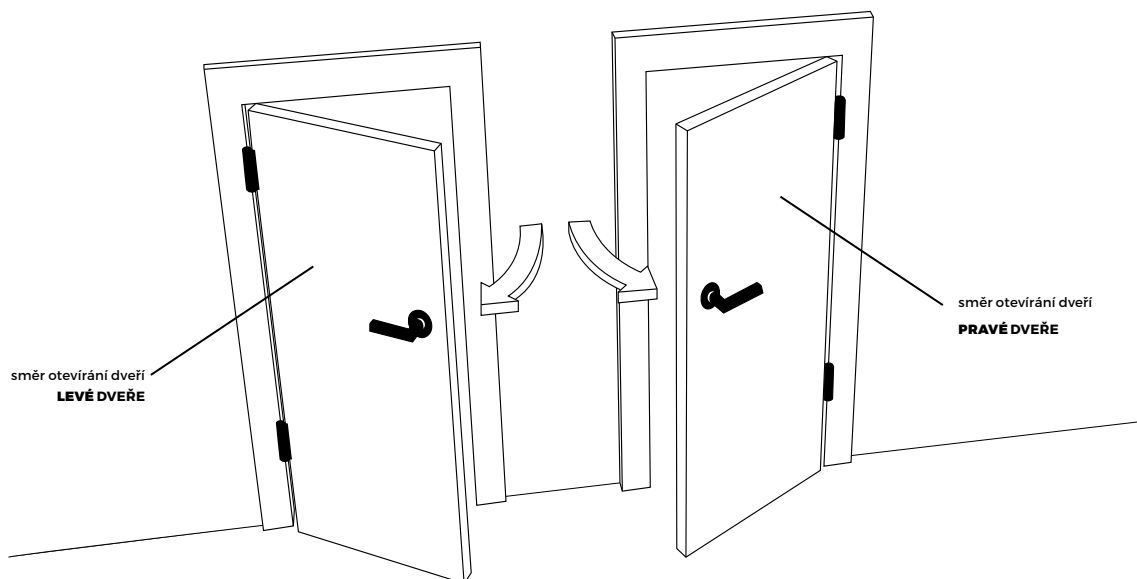

Co je to ROZTEČ štítového kování?

Jedná se o vzdálenost osy kliky a klíče vašich dveří. Tento údaj je zcela zásadní pro nákup správného štítového kování. Nejběžnější rozteče jsou 72 a 90mm, u bezpečnostního kování mohou být i 92mm.

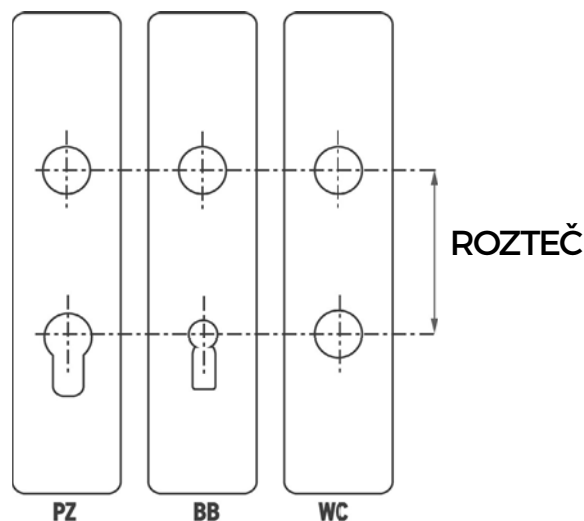

HOW TO SELECT THE RIGHT FITTINGS?

The range of products offered – door fittings, individual shapes, combinations and designs - is so extensive that at first sight it may be very difficult for a customer to understand it. The decision regarding the design depends solely on you and we will be more than happy to help you finding the right solution in terms of technical parameters.:

1. TYPE OF FITTINGS

What type of door fittings is more suitable for your door – rosette or plate fittings?

ROSETTE - consists of two parts – separate handle and a rosette for lock.

- elegant and modern type of fitting popular especially in modern interiors and office buildings
- the inner system of screwing ensures a long lifetime of the fitting, fixing bolts are covered with rosettes thus making the rosette fittings look elegant at all times
- apart from the design of the handle itself we also think about the shape of rosette - round, oval or square

PLATE - it is a one-piece door fitting with a hole for a lock and a handle covered with one plate.

- easy to mount using visible bolts
- the most common and long-established type of fitting which will surely find its place in all types of interiors from flats to small huts and even garden sheds.

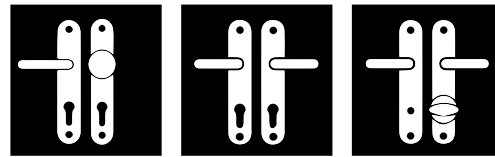
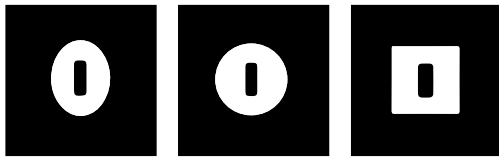

2. TYPE OF LOCK

Naturally the type of lock and key corresponds with particular location of the door fitting. You can find following designations in our catalogue as well as in our e-shop:



PZ - abbreviation for a key and a lock so called "fabka"



BB - a hole for a standard dosic key is a part of fitting



WC - set used primarily in lavatories and bathrooms – in order to lock the door there is a WC small handle from the inner side, from the outer side there is a rosette with a keyway thus in case of an emergency the door can be unlocked from the outer side using any flat object.

3. COMBINATION OF FITTINGS

Not all doors require a handle. What combination of door fittings do you really need?



Handle handle



Handle knob

3. ORIENTATION OF FITTINGS

The decision whether to order left or right handle is nearly the only thing which you need to do yourself and do it well. In order to be able to decide there is a simple help - if you use your right hand to open the door, it means it is a right handle. The same applies for the left handle. Left hand will always be used while opening the door. If you are able to open left handle using your right hand, it is the wrong way to do so or you stand with your back facing the door. In order to respect the instruction principles we would like to add some more specific graphics which you will surely find helpful.

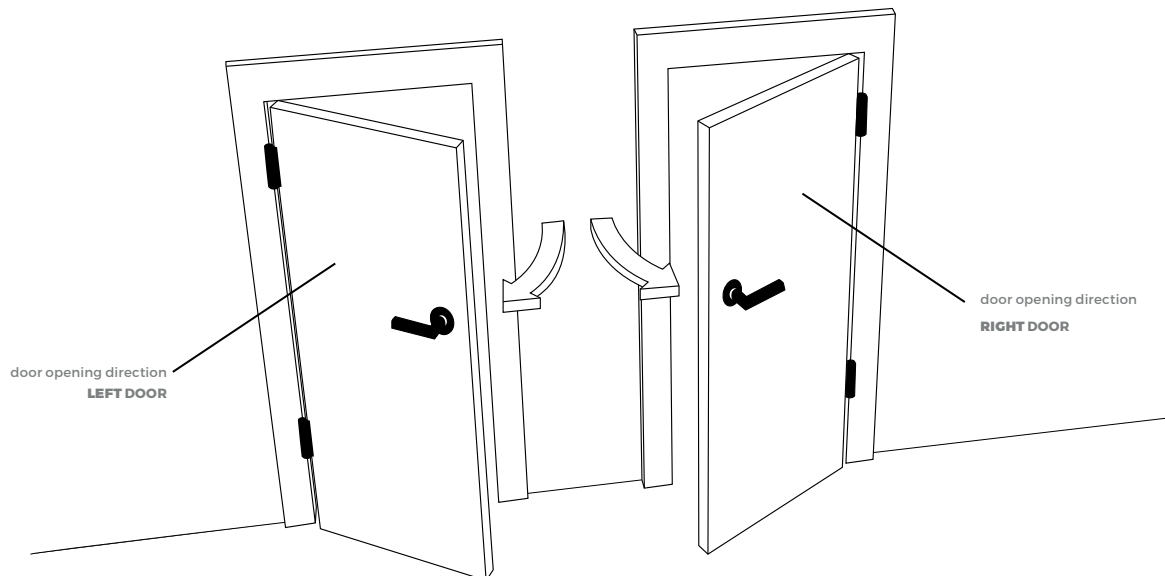

What is a PITCH of label fitting?

It is a distance between a handle axis and your door key. This figure is absolutely crucial when buying the right plate fitting. The most common pitches are 72 and 90 mm, up to 92 mm in case of security door.

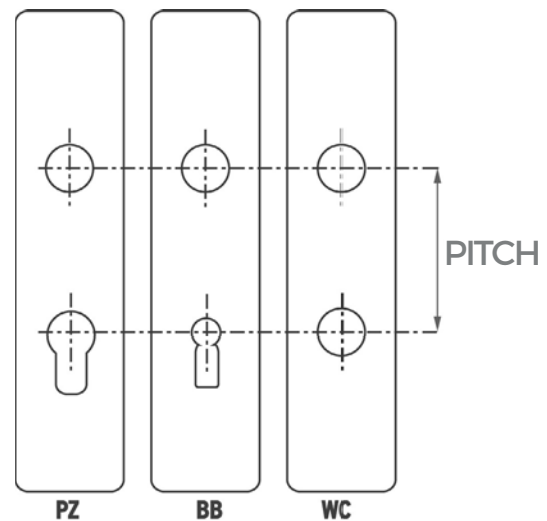

VÝBĚR CYLINDRICKÉ VLOŽKY

Pro správný výběr cylindrické vložky potřebujete znát její celkovou délku. Položte osu upevňovacího šroubu vložky na střed pravítka a změřte oba rozměry - A i B.

Při měření nezapomeňte připočítat tloušťku štítku nebo rozety na každé straně dveří.

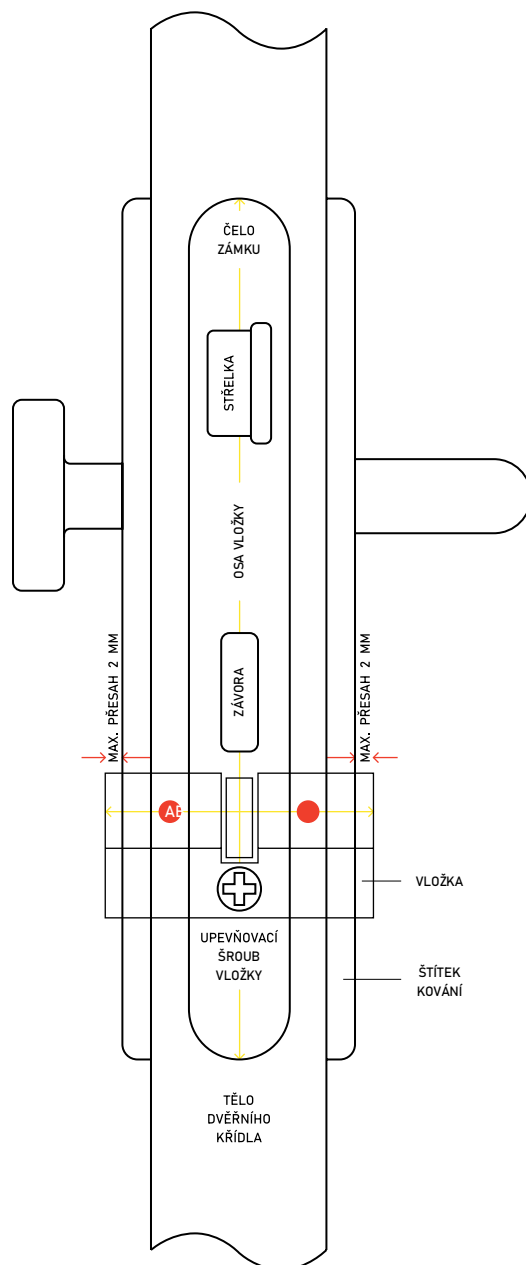

VLOŽKA S OTOČNÝM KNOFLÍKEM

Pozor - důležitá je nejen informace o délce (tedy rozměrech A a B), ale i upřesnění, zda knoflík bude na kratší nebo delší straně vložky.

BEZPEČNOSTNÍ VLOŽKA

Pozor - z pohledu bezpečnosti je zcela zásadní, aby cylindrická vložka lícovala s vnějším štítem kování a nepřechňovala o více, než 1mm. Zabrání to jejímu násilnému vylomení.

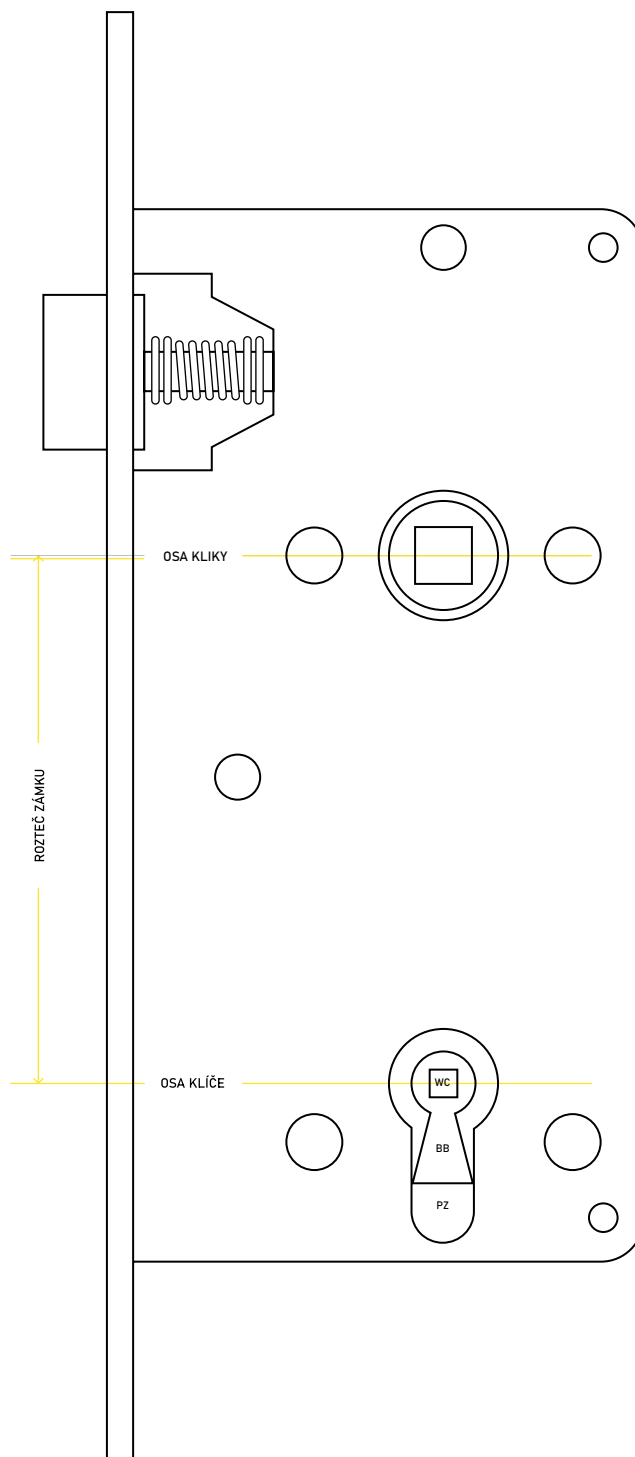

VÝBĚR ŠTÍTOVÉHO KOVÁNÍ

Při volbě štítového kování je nutné změřit rozteč - jedná se o vzdálenost mezi otvorem pro kliku a otvorem pro klíč. Nejběžnější rozteče jsou 72mm a 90mm, u bezpečnostního kování 92mm.

JAK U NÁS NAKOUPÍTE?

Vybrali jste si to správné a nejkrásnější dveřní kování a nevíte, kde koupit nebo jak objednat? Pro výběr a nákup našich dveřních kování je vám k dispozici.

Síť našich obchodních partnerů

spolupracujeme s řadou skvělých partnerů (distributorů a prodejců dveří, dveřních kování a bytových doplňků, architektů či bytových designérských studií) - seznam naleznete na www.matekliku.cz/prodejni-mista

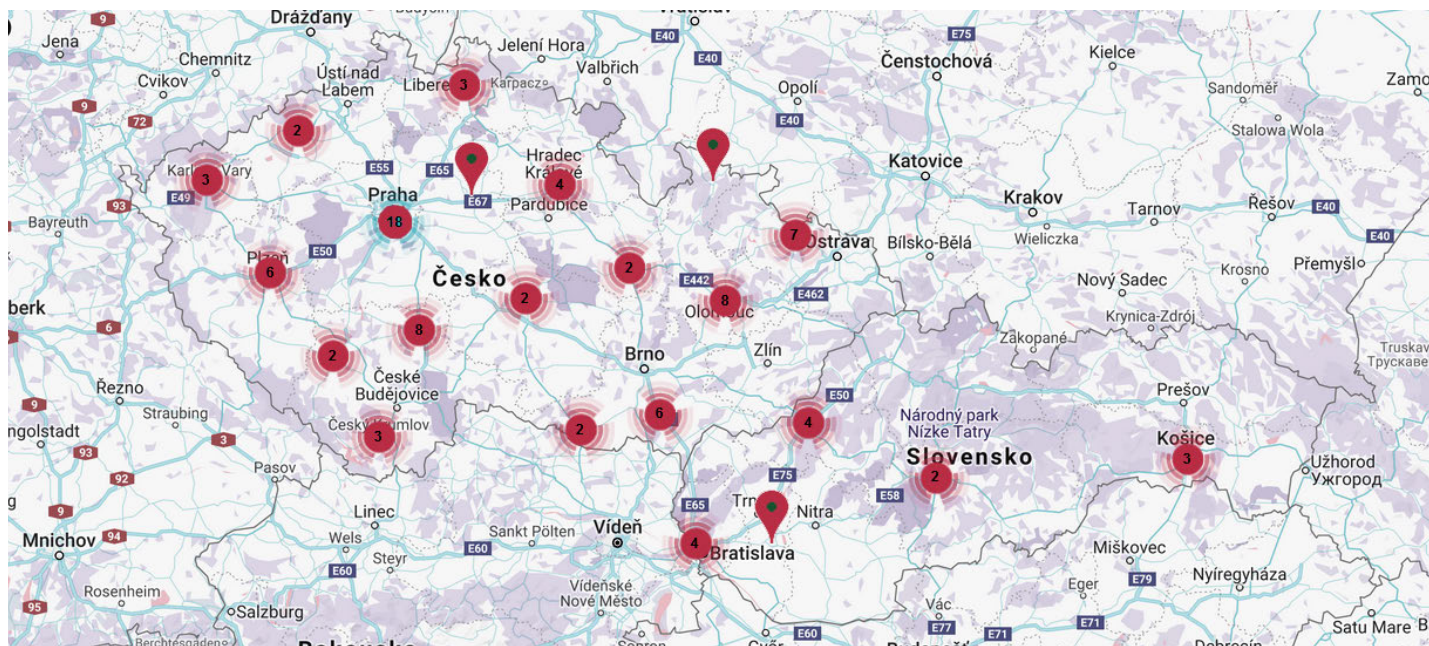

02 Firemní prodejna Cobra

Jeremiášova 2633, Praha 13

03 E-shop

www.matekliku.cz

04 E-mail

objednejte přímo na emailu objednavky@cobra-cz.cz

Naším hlavním cílem je vaše spokojenost. Proto pokud v katalogu nebo na www.matekliku.cz naleznete informaci, které zcela nerozumíte, kontaktujte nás nebo naše obchodní partnery, rádi vám poradíme. Telefonní číslo: +420 235 003 107 nebo mobilní číslo: +420 602 440 628.

Veškeré změny technického charakteru i základních cen jsou vyhrazeny. Uvedené základní ceny bez DPH platí do vydání nového katalogu nebo jeho aktualizace. Právo na tiskové chyby vyhrazeno. Skutečná barva nebo vzhled výrobku a rozměr se může lišit.

Dveřní kování je certifikováno dle ČSN 19006 a je určeno k montáži na standardní interiérové dveře. Montáž doporučujeme svěřit odborné firmě.

Informací není nikdy dost. Webové stránky www.matekliku.cz vám nabídnou více informací o našich produktech, službách i řadu dalších potřebných informací.

online katalog a eshop s kompletní nabídkou COBRA



informace o novinkách a trendech v sekci Designový svět

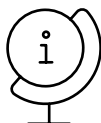

asistenta prodeje - sekci, ve které můžete snadno podle vašich parametrů filtrovat kování, ze kterých budete vybírat

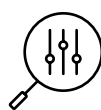

montážní návody a certifikace



...a řadu dalších informací

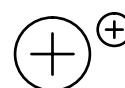



To, co je pro ženu krásný malý šperk nebo pro muže správný kapesníček v saku, může být pro váš byt nebo dům správně zvolená klika.

Můžete investovat mnoho času i peněz do volby podlah, oken nebo třeba kuchyňské linky a bude to úplně v pořádku. Šperkem, který zvýrazní styl vaší domácnosti, se ale mohou stát právě kliky a kování na vašich dveřích. Nejde totiž jen o funkční prostředek k otevírání dveří - při správné volbě skutečně plní funkci estetického doplňku, kterého se každodenně dotýkáme, vnímáme ho, a který by měl respektovat osobitost a design našeho bytu či domu.

What a beautiful little piece of jewellery does for a woman or appropriately chosen handkerchief in a jacket for a man, well selected door handle can do for your flat or house.

You can surely invest plenty of time and money in the right choice of floorboards, windows or even a kitchen line and it will be perfectly fine. However, the gem that may enhance your household style can simply be the right choice of door handles and fittings. It is not just functional device for opening doors, but also - if appropriately selected - it can undoubtedly perform the function of an aesthetic accessory which we touch and perceive on daily basis. It should therefore respect the distinctiveness and the design of our flat or house.





PREMIUM

COBRA 
design by NOVAGE

21 Infinity
21 Spectra
21 Ultima

Kanelaz

22 Kanelaz 1745



Spectra

COBRA 

	CZK		EUR	
	bez DPH	s DPH	bez DPH	s DPH
Bez sp. rozet	3350,0	4054,0	142,6	171,1
rozeta BB, PZ (pár)	450,0	545,0	19,1	22,9
WC set	700,0	847,0	24,8	35,8



Spectra

COBRA 

	CZK		EUR	
	bez DPH	s DPH	bez DPH	s DPH
Bez sp. rozet	3150,0	3812,0	134,0	160,9
rozeta BB, PZ (pár)	400,0	484,0	17,0	20,4
WC set	650,0	787,0	27,7	33,2



Infinity

COBRA 

	CZK		EUR	
	bez DPH	s DPH	bez DPH	s DPH
Bez sp. rozet	3350,0	4054,0	142,6	171,1
rozeta BB, PZ (pár)	450,0	545,0	19,1	22,9
WC set	700,0	847,0	29,8	35,8



Infinity

COBRA 

	CZK		EUR	
	bez DPH	s DPH	bez DPH	s DPH
Bez sp. rozet	3150,0	3812,0	134,0	160,9
rozeta BB, PZ (pár)	400,0	484,0	17,0	20,4
WC set	650,0	787,0	27,7	33,2



Ultima

COBRA 

	CZK		EUR	
	bez DPH	s DPH	bez DPH	s DPH
Bez sp. rozet	3350,0	4054,0	142,6	171,1
rozeta BB, PZ (pár)	450,0	545,0	19,1	22,9
WC set	700,0	847,0	29,8	35,8



Ultima

COBRA 

	CZK		EUR	
	bez DPH	s DPH	bez DPH	s DPH
Bez sp. rozet	3150,0	3812,0	134,0	160,9
rozeta BB, PZ (pár)	400,0	484,0	17,0	20,4
WC set	650,0	787,0	27,7	33,2



Kanelaz 1745

	CZK		EUR	
	bez DPH	s DPH	bez DPH	s DPH
Klika bez s.r.	2255,-	2729,-	96,0	115,1
Klika BB/PZ	2525,-	3055,-	107,4	128,9
Klika WC	2760,-	3340,-	117,4	140,9

	CZK		EUR	
	bez DPH	s DPH	bez DPH	s DPH
Klika bez s.r.	2255,-	2729,-	96,0	115,1
Klika BB/PZ	2525,-	3055,-	107,4	128,9
Klika WC	2760,-	3340,-	117,4	140,9



ONS



OS

	CZK		EUR	
	bez DPH	s DPH	bez DPH	s DPH
Klika bez s.r.	2255,-	2729,-	96,0	115,1
Klika BB/PZ	2525,-	3055,-	107,4	128,9
Klika WC	2760,-	3340,-	117,4	140,9



MB

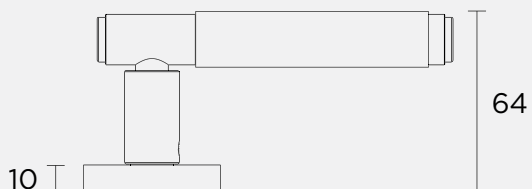

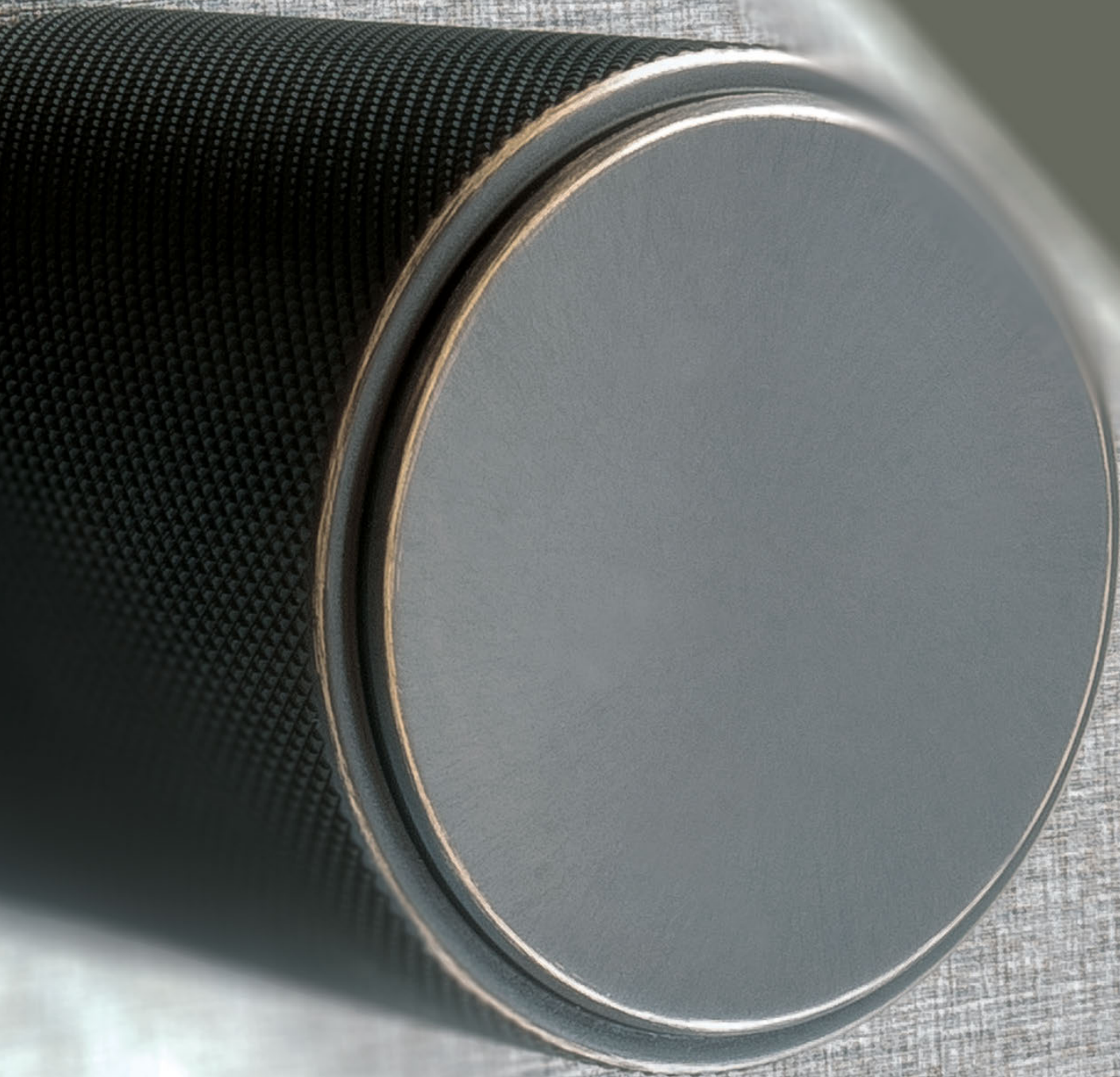



IN

Nerez Classic

MATT STAINLESS STEEL CLASSIC

26 Alena-S
26 Bianca-R
26 Gussy
26 Gussy-R
26 Gussy-S
26 Loft
27 Loft-R
27 Loft-R ovál
27 Nova-S

27 Paola
27 Paola-R
27 Pavla-H
28 Pavla-S
28 Plaza
28 Plaza-H
28 Plaza-R
28 Plaza-S
28 Sali

29 Sali-R
29 Sali-S
29 Ufo
29 Ufo-R
29 Ufo-R ovál
29 Ufo Slim
30 Vision
30 Vision-R
30 Vision-R ovál

30 Vision-R plochá rozeta
30 Vision-S
30 Vision-S plochá rozeta
31 Zoe-R
31 Koule pevná Luna
31 Koule pevná Star
31 Koule pevná Stella

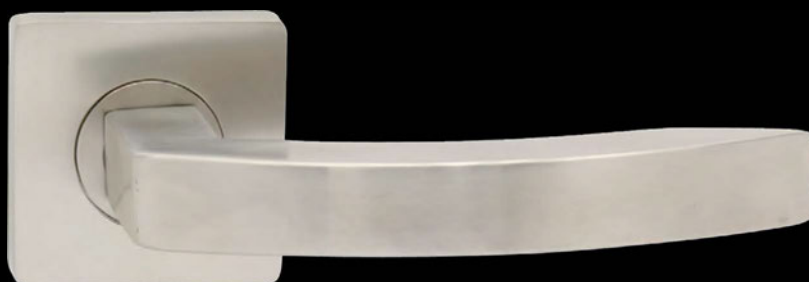



Nerezové kování představuje skvělou volbu vhodnou i pro nejnáročnější uživatele. Díky modernímu vzhledu je často používáné i v designových interiérech či moderních objektech. Vysoká odolnost a bezúdržbovost předurčuje nerezové kliky i do více zatěžovaných prostor.

Stainless steel fitting represents a great choice which even the most demanding end-users will find satisfactory. Thanks to its modern look it is often used in design interiors or modern premises. High resilience and barely any maintenance predetermines stainless steel handles to be fitted even in more stressed areas.

Alena-S

IN **200 tis.** **KR**

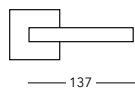

IN

	CZK	bez DPH	s DPH
☞ BB/PZ	685,-	685,-	829,-
☞ WC	915,-	915,-	1107,-
☞ PZ-LI/RE	915,-	915,-	1107,-
	EUR	bez DPH	s DPH
☞ BB/PZ	29,1	29,1	35,0
☞ WC	38,9	38,9	46,7
☞ PZ-LI/RE	38,9	38,9	46,7



Bianca-R

IN **200 tis.** **KR**

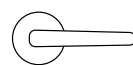

IN

	CZK	bez DPH	s DPH
☞ BB/PZ	890,-	890,-	1077,-
☞ WC	1115,-	1115,-	1349,-
☞ PZ-LI/RE	1115,-	1115,-	1349,-
	EUR	bez DPH	s DPH
☞ BB/PZ	37,9	37,9	45,4
☞ WC	47,4	47,4	56,9
☞ PZ-LI/RE	47,4	47,4	56,9



Giussy

IN **200 tis.** **KR**

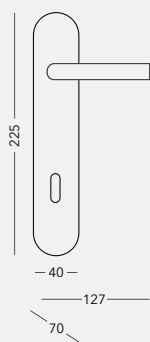

IN

	CZK	bez DPH	s DPH
☞ BB/PZ	475,-	475,-	575,-
☞ WC	665,-	665,-	805,-
☞ PZ-LI/RE	730,-	730,-	883,-
	EUR	bez DPH	s DPH
☞ BB/PZ	20,2	20,2	24,3
☞ WC	28,3	28,3	34,0
☞ PZ-LI/RE	31,1	31,1	37,3



Giussy-R

IN **200 tis.** **KR**



IN **OCH** **OFS**

	CZK	bez DPH	s DPH
☞ BB/PZ	665,-	665,-	805,-
☞ WC	885,-	885,-	1071,-
☞ PZ-LI/RE	885,-	885,-	1071,-
	EUR	bez DPH	s DPH
☞ BB/PZ	28,3	28,3	34,0
☞ WC	37,7	37,7	45,2
☞ PZ-LI/RE	37,7	37,7	45,2



Giussy-S

IN **200 tis.** **KR**



IN

	CZK	bez DPH	s DPH
☞ BB/PZ	835,-	835,-	1010,-
☞ WC	1050,-	1050,-	1271,-
☞ PZ-LI/RE	1050,-	1050,-	1271,-
	EUR	bez DPH	s DPH
☞ BB/PZ	35,5	35,5	42,6
☞ WC	44,7	44,7	53,6
☞ PZ-LI/RE	44,7	44,7	53,6



Loft

IN **200 tis.**

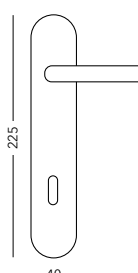

IN

	CZK	bez DPH	s DPH
☞ BB/PZ	475,-	475,-	575,-
☞ WC	665,-	665,-	805,-
☞ PZ-LI/RE	730,-	730,-	883,-
	EUR	bez DPH	s DPH
☞ BB/PZ	20,2	20,2	24,3
☞ WC	28,3	28,3	34,0
☞ PZ-LI/RE	31,1	31,1	37,3



Loft-R

200 tis. KR

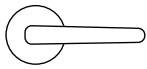

133

55
72

	CZK	bez DPH	s DPH
BB/PZ	665,-	665,-	805,-
WC	890,-	890,-	1077,-
PZ-LI/RE	890,-	890,-	1077,-
EUR			
BB/PZ	28,3	28,3	34,0
WC	37,9	37,9	45,4
PZ-LI/RE	37,9	37,9	45,4



IN

Loft-R ovál

200 tis. BV KR

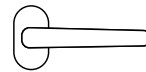

138

65
32
57

	CZK	bez DPH	s DPH
BB/PZ	475,-	475,-	575,-
WC	610,-	610,-	738,-
PZ-LI/RE	775,-	775,-	938,-
EUR			
BB/PZ	20,2	20,2	24,3
WC	26,0	26,0	31,1
PZ-LI/RE	33,0	33,0	39,6



IN

Nelze namontovat s klasickým zadlabávacím zámkem

Nova-S

200 tis. KR

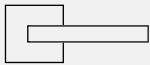

134

55
62

	CZK	bez DPH	s DPH
BB/PZ	775,-	775,-	938,-
WC	1000,-	1000,-	1211,-
PZ-LI/RE	1000,-	1000,-	1211,-
EUR			
BB/PZ	33,0	33,0	39,6
WC	42,6	42,6	51,1
PZ-LI/RE	42,6	42,6	51,1

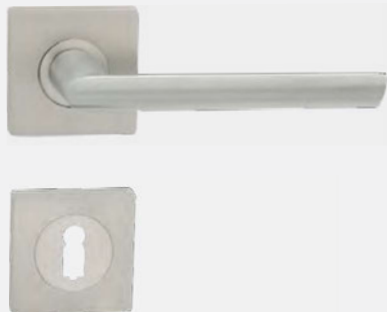

IN

Paola

200 tis. KR



225

40
135
70

	CZK	bez DPH	s DPH
BB/PZ	475,-	475,-	575,-
WC	665,-	665,-	805,-
PZ-LI/RE	730,-	730,-	883,-
EUR			
BB/PZ	20,2	20,2	24,3
WC	28,3	28,3	34,0
PZ-LI/RE	31,1	31,1	37,3



IN

Paola-R

200 tis. KR

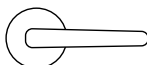

137

55
70

	CZK	bez DPH	s DPH
BB/PZ	665,-	665,-	805,-
WC	890,-	890,-	1077,-
PZ-LI/RE	890,-	890,-	1077,-
EUR			
BB/PZ	28,3	28,3	34,0
WC	37,9	37,9	45,4
PZ-LI/RE	37,9	37,9	45,4



IN

Pavla-S

200 tis. KR



129

55
69

	CZK	bez DPH	s DPH
BB/PZ	835,-	835,-	1010,-
WC	1060,-	1060,-	1283,-
PZ-LI/RE	1060,-	1060,-	1283,-
EUR			
BB/PZ	35,5	35,5	42,6
WC	45,1	45,1	54,1
PZ-LI/RE	45,1	45,1	54,1

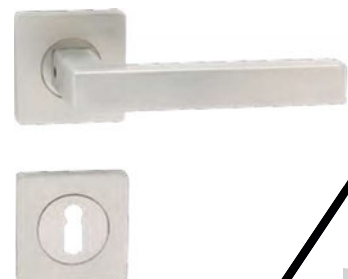

IN

Pavla-H



CZK	bez DPH	s DPH
BB/PZ	520,-	629,-
WC	710,-	859,-
EUR	bez DPH	s DPH
BB/PZ	22,1	26,6
WC	30,2	36,3

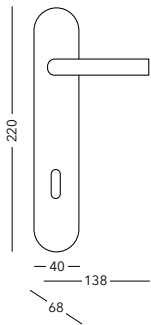

IN

Plaza



CZK	bez DPH	s DPH
BB/PZ	475,-	575,-
WC	665,-	805,-
PZ-LI/RE	725,-	877,-
EUR	bez DPH	s DPH
BB/PZ	20,2	24,3
WC	28,3	34,0
PZ-LI/RE	30,9	37,0

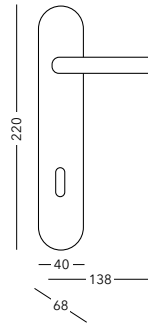

IN

Plaza-H

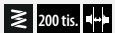

CZK	bez DPH	s DPH
BB/PZ	520,-	629,-
WC	710,-	859,-
EUR	bez DPH	s DPH
BB/PZ	22,1	26,5
WC	30,2	36,3

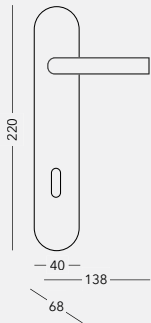

IN

Plaza-R



CZK	bez DPH	s DPH
BB/PZ	675,-	817,-
WC	885,-	1071,-
PZ-LI/RE	885,-	1071,-
EUR	bez DPH	s DPH
BB/PZ	28,7	34,5
WC	37,7	45,2
PZ-LI/RE	37,7	45,2

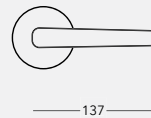

IN F9 F1

Plaza-S



CZK	bez DPH	s DPH
BB/PZ	780,-	944,-
WC	990,-	1198,-
PZ-LI/RE	990,-	1198,-
EUR	bez DPH	s DPH
BB/PZ	33,2	39,8
WC	42,1	50,6
PZ-LI/RE	42,1	50,6

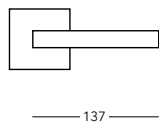

IN F9 F1

Sali



CZK	bez DPH	s DPH
BB/PZ	475,-	575,-
WC	665,-	805,-
PZ-LI/RE	730,-	883,-
EUR	bez DPH	s DPH
BB/PZ	20,2	24,3
WC	28,3	34,0
PZ-LI/RE	31,1	37,3

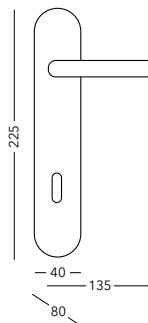

IN

Sali-R

200 tis. KR

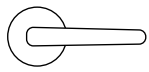

— 135 —



— 55 —
— 79 —

	CZK	bez DPH	s DPH
BB/PZ	550,-	550,-	666,-
WC	775,-	775,-	938,-
PZ-LI/RE	775,-	775,-	938,-
	EUR	bez DPH	s DPH
BB/PZ	23,4	23,4	28,1
WC	33,0	33,0	39,6
PZ-LI/RE	33,0	33,0	39,6



IN

Sali-S

200 tis. KR

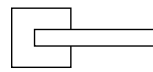

— 135 —



— 55 —
— 79 —

	CZK	bez DPH	s DPH
BB/PZ	665,-	665,-	805,-
WC	890,-	890,-	1077,-
PZ-LI/RE	890,-	890,-	1077,-
	EUR	bez DPH	s DPH
BB/PZ	28,3	28,3	34,0
WC	37,9	37,9	45,4
PZ-LI/RE	37,9	37,9	45,4



IN

Ufo

200 tis. KR

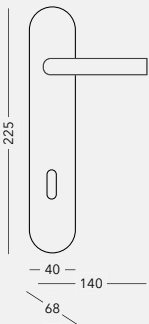

— 40 —
— 140 —
— 68 —

	CZK	bez DPH	s DPH
BB/PZ	475,-	475,-	575,-
WC	665,-	665,-	805,-
PZ-LI/RE	730,-	730,-	883,-
	EUR	bez DPH	s DPH
BB/PZ	20,2	20,2	24,3
WC	28,3	28,3	34,0
PZ-LI/RE	31,1	31,1	37,3



IN

Ufo Slim

200 tis. KR

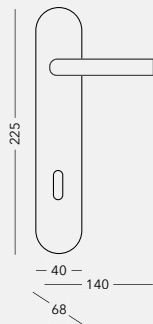

— 40 —
— 140 —
— 68 —

	CZK	bez DPH	s DPH
BB/PZ	530,-	530,-	641,-
WC	720,-	720,-	871,-
	EUR	bez DPH	s DPH
BB/PZ	22,6	22,6	27,1
WC	30,6	30,6	36,8



IN

Ufo-R

200 tis. KR

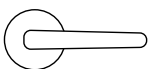

— 140 —



— 55 — 50 mm pro KR
— 68 —

	CZK	bez DPH	s DPH
BB/PZ	610,-	610,-	738,-
WC	835,-	835,-	1010,-
PZ-LI/RE	835,-	835,-	1010,-
	EUR	bez DPH	s DPH
BB/PZ	26,0	26,0	31,1
WC	35,5	35,5	42,6
PZ-LI/RE	35,5	35,5	42,6



IN

Ufo-R ovál

200 tis. KR

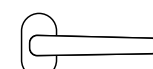

— 140 —



— 32 —
— 67 —

	CZK	bez DPH	s DPH
BB/PZ	500,-	500,-	605,-
WC	610,-	610,-	738,-
PZ-LI/RE	775,-	775,-	938,-
	EUR	bez DPH	s DPH
BB/PZ	21,3	21,3	25,5
WC	26,0	26,0	31,1
PZ-LI/RE	33,0	33,0	39,6



Nelze namontovat
s klasickým
zadlabávacím zámečkem

IN

Vision

IN 200 tis. **KR**

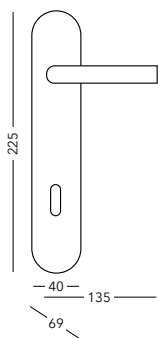

	CZK	bez DPH	s DPH
☞ BB/PZ	475,-	475,-	575,-
☞ WC	665,-	665,-	805,-
☞ PZ-LI/RE	730,-	730,-	883,-
	EUR	bez DPH	s DPH
☞ BB/PZ	20,2	20,2	24,3
☞ WC	28,3	28,3	34,0
☞ PZ-LI/RE	31,1	31,1	37,3



IN

Vision-R

IN 200 tis. **KR**

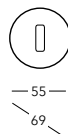
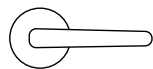

	CZK	bez DPH	s DPH
☞ BB/PZ	550,-	550,-	666,-
☞ WC	775,-	775,-	938,-
☞ PZ-LI/RE	775,-	775,-	938,-
	EUR	bez DPH	s DPH
☞ BB/PZ	23,4	23,4	28,1
☞ WC	33,0	33,0	39,6
☞ PZ-LI/RE	33,0	33,0	39,6



IN

Vision-R ovál

IN 200 tis. **KR**

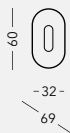
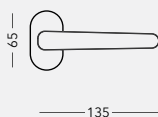

	CZK	bez DPH	s DPH
☞ BB/PZ	500,-	500,-	605,-
☞ WC	610,-	610,-	738,-
☞ PZ-LI/RE	775,-	775,-	938,-
	EUR	bez DPH	s DPH
☞ BB/PZ	21,3	21,3	25,5
☞ WC	26,0	26,0	31,1
☞ PZ-LI/RE	33,0	33,0	39,6



IN

Vision-R plochá rozeta

IN 200 tis. **KR**

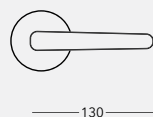

	CZK	bez DPH	s DPH
☞ BB/PZ	1065,-	1065,-	1288,-
☞ WC	1595,-	1595,-	1930,-
	EUR	bez DPH	s DPH
☞ BB/PZ	45,3	45,3	54,4
☞ WC	67,9	67,9	81,4



plochá magnetická rozeta, hloubka rozety 3mm

IN

Vision-S

IN 200 tis. **KR**

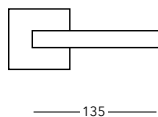

	CZK	bez DPH	s DPH
☞ BB/PZ	775,-	775,-	938,-
☞ WC	1000,-	1000,-	1211,-
☞ PZ-LI/RE	1000,-	1000,-	1211,-
	EUR	bez DPH	s DPH
☞ BB/PZ	33,0	33,0	39,6
☞ WC	42,6	42,6	51,1
☞ PZ-LI/RE	42,6	42,6	51,1



IN

Vision-S plochá rozeta

IN 200 tis. **KR**

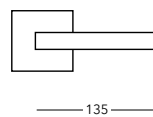

	CZK	bez DPH	s DPH
☞ BB/PZ	1065,-	1065,-	1288,-
☞ WC	1595,-	1595,-	1930,-
	EUR	bez DPH	s DPH
☞ BB/PZ	45,3	45,3	54,4
☞ WC	67,9	67,9	81,4



plochá magnetická rozeta, hloubka rozety 3mm

IN

Zoe-R

IN KR

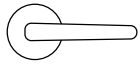

— 146 —



— 50 —
— 65 —

🔑 CZK	bez DPH	s DPH
BB/PZ	650,-	787,-
WC	890,-	1077,-
🔑 PZ-LI/RE	890,-	1077,-
EUR	bez DPH	s DPH
BB/PZ	27,7	33,2
WC	37,9	45,4
🔑 PZ-LI/RE	37,9	45,4



IN ONS OFS

Koule pevná Luna

KR

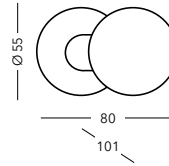

— Ø 55 —
— 80 —
— 101 —



CZK	bez DPH	s DPH
cena ks	590,-	714,-
EUR	bez DPH	s DPH
cena ks	25,1	30,1
obj. číslo	C4199E6K55	

Samostatná koule bez rozety na vyžádání.
Varianty provedení levá, pravá, pevná, otočná.

IN

Koule pevná Star

KR

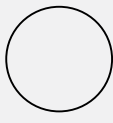

— 49 —
— 57 —



CZK	bez DPH	s DPH
cena ks	380,-	460,-
EUR	bez DPH	s DPH
cena ks	16,2	19,4

IN

Samostatná koule bez rozety na vyžádání.
Varianty provedení levá, pravá, pevná, otočná.

Koule pevná Stella

KR



— 55 —
— 55 —
— 62 —



CZK	bez DPH	s DPH
cena ks	420,-	508,-
EUR	bez DPH	s DPH
cena ks	17,9	21,4

IN

Samostatná koule bez rozety na vyžádání.
Varianty provedení levá, pravá, pevná, otočná.





IN

Nerez Economy

MATT STANIELSS STEAL ECONOMY

34	Diva-R III	34	Loft-R III	35	Ufo-R III
34	Giusy-R III	35	Paola-R III	36	Vision-R III
34	Giusy-S III	35	Pavla-R III	36	Vision-S III
34	Iris-R III	35	Pavla-S III		
34	Iris-S III	35	Sali-R III		

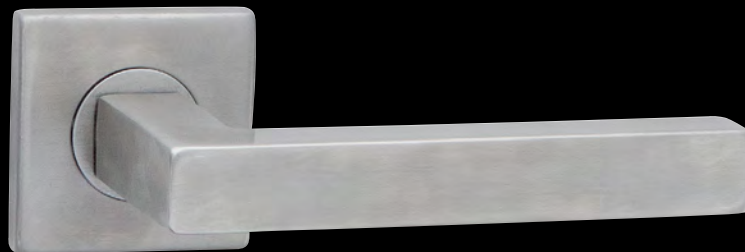



Diva-R III

IN 200 tis. **KR**

CZK	bez DPH	s DPH
BB/PZ	430.-	520.-
WC	540.-	653.-
EUR	bez DPH	s DPH
BB/PZ	18,3	22,0
WC	23,0	27,6

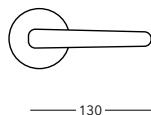

IN

Giussy-R III

IN 200 tis. **KR**

CZK	bez DPH	s DPH
BB/PZ	440.-	532.-
WC	610.-	738.-
PZ-LI/RE	610.-	738.-
EUR	bez DPH	s DPH
BB/PZ	18,7	22,5
WC	26,0	31,1
PZ-LI/RE	26,0	31,1

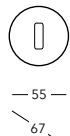
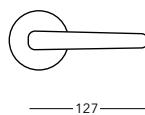

IN **F4** **F9** **F1**

Giussy-S III

IN 200 tis. **KR**

CZK	bez DPH	s DPH
BB/PZ	550.-	666.-
WC	665.-	805.-
PZ-LI/RE	720.-	871.-
EUR	bez DPH	s DPH
BB/PZ	23,4	28,1
WC	28,3	34,0
PZ-LI/RE	30,6	36,8

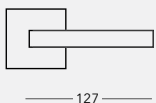

IN **F1** **F9**

Iris-R III

IN 200 tis. **KR**

CZK	bez DPH	s DPH
BB/PZ	440.-	532.-
WC	550.-	666.-
EUR	bez DPH	s DPH
BB/PZ	18,7	22,5
WC	23,4	28,1

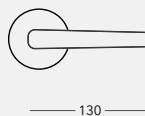

IN

Iris-S III

IN 200 tis. **KR**

CZK	bez DPH	s DPH
BB/PZ	530.-	541.-
WC	720.-	871.-
EUR	bez DPH	s DPH
BB/PZ	22,6	27,1
WC	30,6	36,8

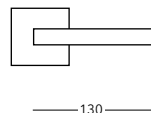

IN

Loft-R III

KR

CZK	bez DPH	s DPH
BB/PZ	305.-	368.-
WC	410.-	495.-
PZ-LI/RE	465.-	563.-
EUR	bez DPH	s DPH
BB/PZ	13,0	15,6
WC	17,4	20,9
PZ-LI/RE	19,8	23,7

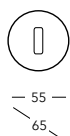
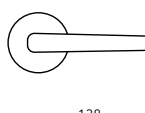

IN

Paola-R III

200 tis. KR

	CZK	bez DPH	s DPH
BB/PZ	305,-	305,-	369,-
WC	410,-	410,-	495,-
PZ-LI/RE	465,-	465,-	563,-
	EUR	bez DPH	s DPH
BB/PZ	13,0	13,0	15,6
WC	17,4	17,4	20,9
PZ-LI/RE	19,8	19,8	23,7

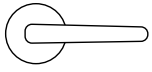

135



55
69



IN

Pavla-R III

200 tis. KR

	CZK	bez DPH	s DPH
BB/PZ	530,-	530,-	641,-
WC	755,-	755,-	914,-
PZ-LI/RE	755,-	755,-	914,-
	EUR	bez DPH	s DPH
BB/PZ	22,5	22,5	27,0
WC	32,1	32,1	38,6
PZ-LI/RE	32,1	32,1	38,6

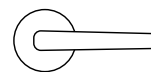

129



55
69



IN

Pavla-S III

200 tis. KR

	CZK	bez DPH	s DPH
BB/PZ	530,-	530,-	641,-
WC	755,-	755,-	914,-
PZ-LI/RE	55,-	55,-	914,-
	EUR	bez DPH	s DPH
BB/PZ	22,6	22,6	27,1
WC	32,1	32,1	38,6
PZ-LI/RE	32,1	32,1	38,6

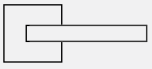

129



55
69



IN

Sali-R III

200 tis. KR

	CZK	bez DPH	s DPH
BB/PZ	305,-	305,-	368,-
WC	410,-	410,-	495,-
PZ-LI/RE	465,-	465,-	563,-
	EUR	bez DPH	s DPH
BB/PZ	13,0	13,0	15,6
WC	17,4	17,4	20,9
PZ-LI/RE	19,8	19,8	23,7

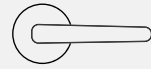

135



55
80



IN

Ufo-R III

200 tis. KR

	CZK	bez DPH	s DPH
BB/PZ	305,-	305,-	368,-
WC	410,-	410,-	495,-
PZ-LI/RE	465,-	465,-	563,-
	EUR	bez DPH	s DPH
BB/PZ	13,0	13,0	15,6
WC	17,4	17,4	20,9
PZ-LI/RE	19,8	19,8	23,7

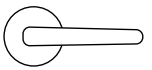

140



55
67



IN

Vision-R III

M 200 tis. **KR**

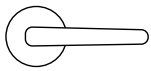

— 135 —



— 55 —
— 63 —



IN

	CZK	bez DPH	s DPH
🔑 BB/PZ		270,-	327,-
WC		440,-	532,-
🔑 PZ-LI/RE		500,-	605,-
EUR			
🔑 BB/PZ		11,5	13,8
WC		18,7	22,5
🔑 PZ-LI/RE		21,3	25,5

Vision-S III

M 200 tis. **KR**

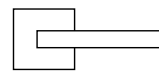

— 135 —



— 55 —
— 70 —



IN

	CZK	bez DPH	s DPH
🔑 BB/PZ		325,-	393,-
WC		530,-	641,-
🔑 PZ-LI/RE		530,-	641,-
EUR			
🔑 BB/PZ		13,8	16,6
WC		22,6	27,1
🔑 PZ-LI/RE		27,2	32,7

COBRA® 

IN





IN

Nerez Project

STANIELSS STEEL PROJECT

41	Loft	43	Ufo	45	Vision
41	Loft-krátký štít	43	Ufo-krátký štít	45	Vision-krátký štít
41	Loft-R	43	Ufo-R	45	Vision-R
41	Loft-ovál	43	Ufo-ovál	45	Vision-ovál





Vision

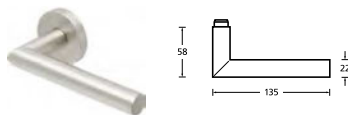

Ufo

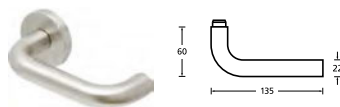

Loft

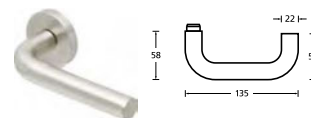

M Kovová vratná pružina
Metal spring

H Objektové kování
Hardware for object

1 mil. Testováno na životnost 1 milion cyklů
Tested for 1 milion cycles

H Fixační kovové výstupky
Fixing metal pins

H Rychlá montáž
Quick assembly

B Kuličkové ložisko
Ball-bearing

- Vhodné pro kategorii použití 4
- Kuličkové ložisko v obou rozetech
- Testováno na životnost 1 milion cyklů
- Kování se zvýšenou axiální pevností
- Extrémně vysoká odolnost proti korozi

- Záruka 30 let na mechanismus
- Uchycení základny metrickými šrouby
- Větší průměr kliky 22 mm
- Velmi rychlá montáž

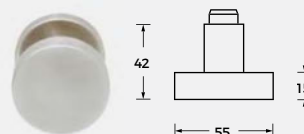
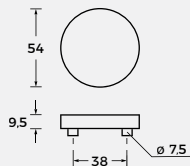

PullBloc® 4.1



Bezúdržbová kuličková ložiska z tvrdě oceli zajišťují **nízké tření, tichý chod a velmi dlouhou životnost.**

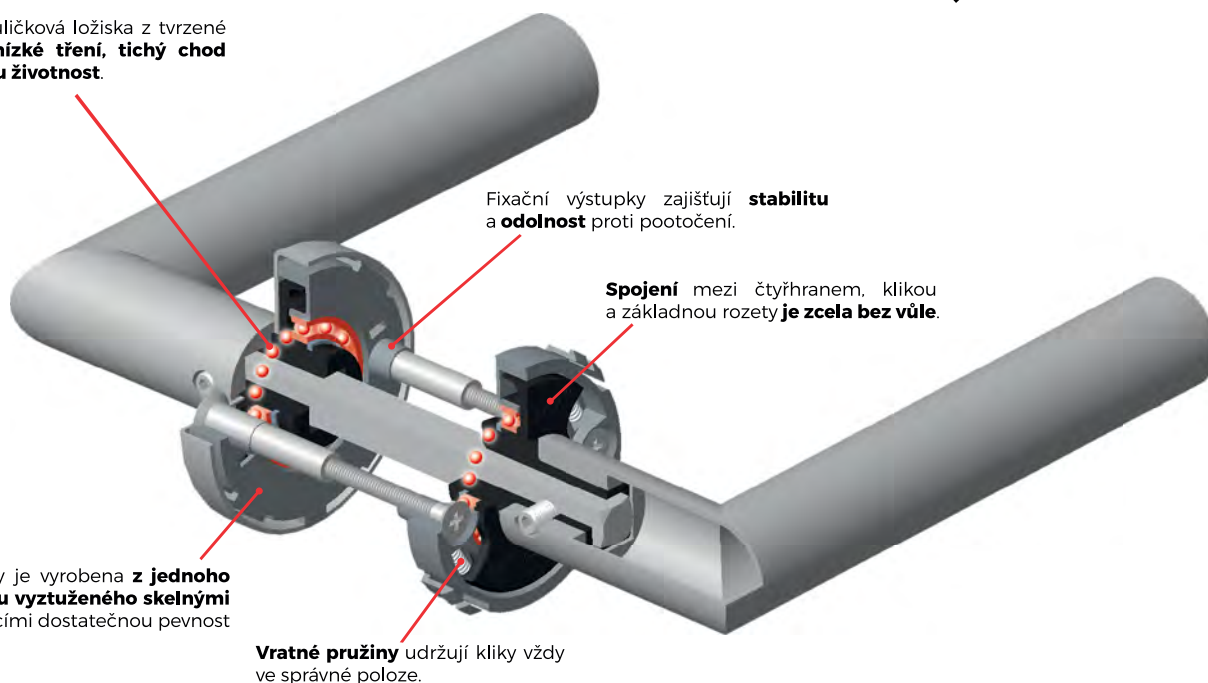

Základna rozety je vyrobena **z jednoho kusu polyamidu vztuženého skelnými vlákny** zaručujícími dostatečnou pevnost pouzdra.

Kategorie použití	Životnost	Hmotnost dveří	Požární odolnost	Ochrana	Odolnost proti korozi	Bezpečnost	Typ ovládání
4*	7	-	0	1	5	0	B

* ČSN EN 1906, kategorie použití, třída 4: vysoká frekvence používání na dveřích, které jsou předmětem častého hrubého používání, např. fotbalové stadiony, kasárna, veřejné toalety, atd.

Loft



PullBloc 3.0

CZK	bez DPH	s DPH
BB/PZ	2 460,-	2 977,-
WC	2 850,-	3 449,-
LI/RE	2 980,-	3 606,-

EUR	bez DPH	s DPH
BB/PZ	104,7	125,6
WC	121,3	145,5
LI/RE	126,8	152,2

IN

Loft-krátký štít



PullBloc 3.0

CZK	bez DPH	s DPH
BB/PZ	2 460,-	2 977,-
WC	2 850,-	3 449,-
LI/RE	2 980,-	3 606,-

EUR	bez DPH	s DPH
BB/PZ	100,0	120,0
WC	116,2	139,4
LI/RE	121,7	146,0

IN u krátkého štítu pouze rozteč 72mm

Loft-R



IN

PullBloc 4.1

CZK	bez DPH	s DPH	EUR	bez DPH	s DPH
BB/PZ	1 960,-	2 372,-	BB/PZ	83,4	100,1
WC	2 320,-	2 807,-	WC	98,7	118,5
LI/RE	2 740,-	3 315,-	LI/RE	116,6	139,9

PullBloc 3.0

CZK	bez DPH	s DPH	EUR	bez DPH	s DPH
BB/PZ	1 250,-	1 513,-	BB/PZ	53,2	63,8
WC	1 620,-	1 960,-	WC	68,9	82,7
LI/RE	2 180,-	2 683,-	LI/RE	92,8	111,3

SlideBloc

CZK	bez DPH	s DPH	EUR	bez DPH	s DPH
BB/PZ	980,-	1 186,-	BB/PZ	41,7	50,0
WC	1 280,-	1 549,-	WC	54,5	65,4
LI/RE	1 580,-	1 912,-	LI/RE	67,2	80,7

Loft-ová



IN

PullBloc 3.0

CZK	bez DPH	s DPH
BB/PZ	2 120,-	2 565,-
WC	2 390,-	2 892,-
LI/RE	2 560,-	3 098,-

EUR	bez DPH	s DPH
BB/PZ	90,2	108,3
WC	101,7	122,0
LI/RE	108,9	130,7

Vision

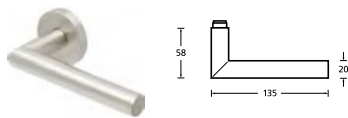

Ufo

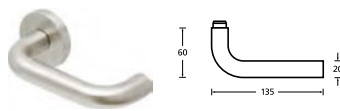

Loft

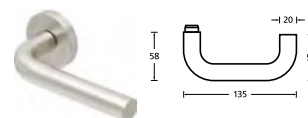

Kovová vratná pružina
Metal spring

Objektové kování
Hardware for object

Rychlá montáž
Quick assembly

Kuličkové ložisko
Ball-bearing

- Vhodné pro kategorii použití 3
- Kuličkové ložisko v obou rozetách
- Vysoká odolnost proti korozi

- Záruka 30 let na mechanismus
- Uchycení základny samořeznými šrouby
- Snadná montáž

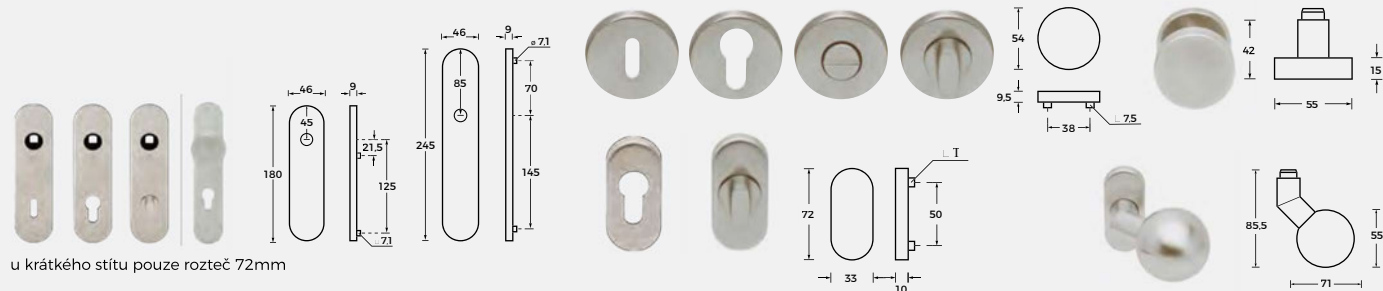

PullBloc® 3.0



Bezúdržbová kuličková ložiska z tvrdné oceli zajišťují **nízké tření, tichý chod a velmi dlouhou životnost.**

Fixační výstupky zajišťují **stabilitu a odolnost** proti pootočení.

Spojení mezi čtyřhranem, klikou a základnou rozetou **je zcela bez vůle.**

Základna rozety je vyrobena z **jednoho kusu polyamidu vyztuženého skelnými vlákny** zaručujícími dostatečnou pevnost pouzdra.

Vratné pružiny udržují kliky vždy ve správné poloze.

Kategorie použití	Životnost	Hmotnost dveří	Požární odolnost	Ochrana	Odolnost proti korozi	Bezpečnost	Typ ovládání
3*	7	-	0	0	3	0	B

* ČSN EN 1906, kategorie použití, třída 3: vysoká frekvence používání veřejností nebo jinými uživateli s malou motivací o pečlivé používání a tam, kde je vysoká pravděpodobnost nesprávného použití, např. dveře u veřejných kanceláří.

Ufo



PullBloc 3.0

CZK	bez DPH	s DPH
BB/PZ	2 460,-	2 977,-
WC	2 850,-	3 449,-
LI/RE	2 980,-	3 606,-

EUR	bez DPH	s DPH
BB/PZ	104,7	125,6
WC	121,3	145,5
LI/RE	126,8	152,2

IN

Ufo-krátký štít



PullBloc 3.0

CZK	bez DPH	s DPH
BB/PZ	2 460,-	2 977,-
WC	2 850,-	3 449,-
LI/RE	2 980,-	3 606,-

EUR	bez DPH	s DPH
BB/PZ	100,0	120,0
WC	116,2	139,4
LI/RE	121,7	146,0

IN u krátkého štítu pouze rozteč 72mm

Ufo-R



IN

PullBloc 4.1

CZK	bez DPH	s DPH	EUR	bez DPH	s DPH
BB/PZ	1 960,-	2 372,-	BB/PZ	83,4	100,1
WC	2 320,-	2 807,-	WC	98,7	118,5
LI/RE	2 740,-	3 315,-	LI/RE	116,6	139,9

PullBloc 3.0

CZK	bez DPH	s DPH	EUR	bez DPH	s DPH
BB/PZ	1 250,-	1 513,-	BB/PZ	53,2	63,8
WC	1 620,-	1 960,-	WC	68,9	82,7
LI/RE	2 180,-	2 683,-	LI/RE	92,8	111,3

SlideBloc

CZK	bez DPH	s DPH	EUR	bez DPH	s DPH
BB/PZ	980,-	1 186,-	BB/PZ	41,7	50,0
WC	1 280,-	1 549,-	WC	54,5	65,4
LI/RE	1 580,-	1 912,-	LI/RE	67,2	80,7

Ufo-ovál



IN

PullBloc 3.0

CZK	bez DPH	s DPH
BB/PZ	2 120,-	2 565,-
WC	2 390,-	2 892,-
LI/RE	2 560,-	3 098,-

EUR	bez DPH	s DPH
BB/PZ	90,2	108,3
WC	101,7	122,0
LI/RE	108,9	130,7

Vision

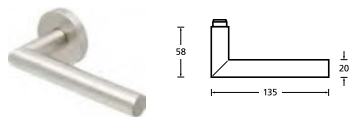

Kovová vratná pružina
Metal spring

- Vhodné pro kategorii použití 3
- Testováno na životnost 200 000 cyklů
- Kluzné ložisko v obou rozetách
- Záruka 10 let na mechanismus

Ufo

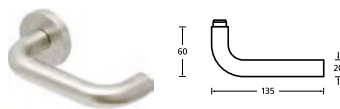

Objektové kování
Hardware for object

- Vysoká odolnost proti korozi
- Uchytení základny samořeznými šrouby
- Snadná montáž

Loft

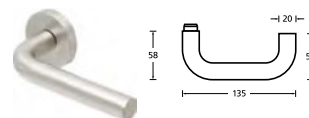

Rychlá montáž
Quick assembly

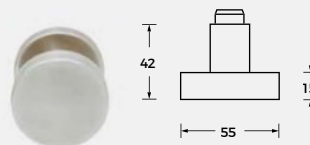
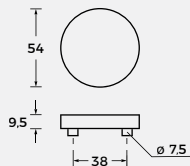

SlideBloc®



Bezúdržbová kluzná ložiska zajišťují **tichý chod a vysokou spolehlivost.**

Fixační výstupky zajišťují **stabilitu a odolnost** proti pootočení.

Spojení mezi čtyřhranem, klikou a základnou rozetou **je zcela bez vůle.**

Základna rozety je vyrobena z **jednoho kusu polyamidu vyztuženého skelnými vlákny** zaručujícími dostatečnou pevnost pouzdra.

Vratné pružiny udržují kliky vždy ve správné poloze.

Kategorie použití	Životnost	Hmotnost dveří	Požární odolnost	Ochrana	Odolnost proti korozi	Bezpečnost	Typ ovládání
3*	7	-	0	0	3	0	B

* ČSN EN 1906, kategorie použití, třída 3: vysoká frekvence používání veřejností nebo jinými uživateli s malou motivací o pečlivé používání a tam, kde je vysoká pravděpodobnost nesprávného použití, např. dveře u veřejných kancelářích.

Vision



PullBloc 3.0

CZK	bez DPH	s DPH
BB/PZ	2 460,-	2 977,-
WC	2 850,-	3 449,-
LI/RE	2 980,-	3 606,-

EUR	bez DPH	s DPH
BB/PZ	104,7	125,6
WC	121,3	145,5
LI/RE	126,8	152,2

IN

Vision-krátký štít



PullBloc 3.0

CZK	bez DPH	s DPH
BB/PZ	2 460,-	2 977,-
WC	2 850,-	3 449,-
LI/RE	2 980,-	3 606,-

EUR	bez DPH	s DPH
BB/PZ	100,0	120,0
WC	116,2	139,4
LI/RE	121,7	146,0

IN u krátkého štítu pouze rozteč 72mm

Vision-R



IN

PullBloc 4.1

CZK	bez DPH	s DPH	EUR	bez DPH	s DPH
BB/PZ	1 960,-	2 372,-	BB/PZ	83,4	100,1
WC	2 320,-	2 807,-	WC	98,7	118,5
LI/RE	2 740,-	3 315,-	LI/RE	116,6	139,9

PullBloc 3.0

CZK	bez DPH	s DPH	EUR	bez DPH	s DPH
BB/PZ	1 250,-	1 513,-	BB/PZ	53,2	63,8
WC	1 620,-	1 960,-	WC	68,9	82,7
LI/RE	2 180,-	2 683,-	LI/RE	92,8	111,3

SlideBloc

CZK	bez DPH	s DPH	EUR	bez DPH	s DPH
BB/PZ	980,-	1 186,-	BB/PZ	41,7	50,0
WC	1 280,-	1 549,-	WC	54,5	65,4
LI/RE	1 580,-	1 912,-	LI/RE	67,2	80,7

Vision-ovál



IN

PullBloc 3.0

CZK	bez DPH	s DPH
BB/PZ	2 120,-	2 565,-
WC	2 390,-	2 892,-
LI/RE	2 560,-	3 098,-

EUR	bez DPH	s DPH
BB/PZ	90,2	108,3
WC	101,3	121,5
LI/RE	108,9	130,7



OCS

Chrom matný

SATIN CHROME

48 Alexis-R	49 Mega-S	51 1485
48 Alt-wien	49 Milena	51 1495
48 Elegant	50 Milena-R	51 1515
48 Elsa-S	50 Orion	51 1555
48 Esme-S	50 Orion-R	52 1505
48 Spring-S	50 Presso-S	52 1535
49 Jerome-S	50 Q-arte	
49 Laura	50 Q-arte-S	52 Koule pevná
49 Laura-R	51 865	Victory
49 Mega-R	51 1145	



Hledáte praktické řešení pro vaše dveře? Chromová klika v matné úpravě je to pravé. Nenápadně ozdobí váš interiér, lehké záblesky studených odstínů se výborně hodí do moderních i tradičních interiérů.

Are you searching for a practical solution for your door? Chrome handle in frosted design is what you are looking for. Without calling too much attention it will decorate your interior. Light flashes of cold shades beautifully match both modern as well as traditional interiors.

Alexis-R

W 200 tis. **KR**

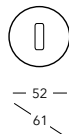
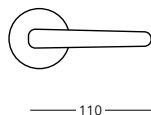

OCS **ONS**

	CZK	bez DPH	s DPH
BB/PZ	440.-	440.-	532.-
WC	550.-	550.-	666.-
PZ-LI/RE	610.-	610.-	738.-
	EUR	bez DPH	s DPH
BB/PZ	18,7	18,7	22,5
WC	23,4	23,4	28,1
PZ-LI/RE	26,0	26,0	31,1



Alt-Wien

W 200 tis.

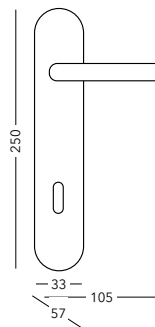

OCS **OC** **ONS** **OLV** **OV**
OFS **K**

	CZK	bez DPH	s DPH
BB/PZ	730.-	730.-	883.-
WC	930.-	930.-	1125.-
PZ-LI/RE	1010.-	1010.-	1222.-
	EUR	bez DPH	s DPH
BB/PZ	31,1	31,1	37,3
WC	39,6	39,6	47,5
PZ-LI/RE	43,0	43,0	51,6



Elegant

W 200 tis.

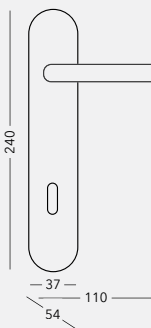

OCS **ONS** **OLV** **OFS** **OC**
OV **K**

	CZK	bez DPH	s DPH
BB/PZ	600.-	600.-	726.-
WC	745.-	745.-	901.-
PZ-LI/RE	815.-	815.-	986.-
	EUR	bez DPH	s DPH
BB/PZ	25,5	25,5	30,6
WC	31,7	31,7	38,0
PZ-LI/RE	34,7	34,7	41,6



Elsa-S

W 200 tis. **PR**

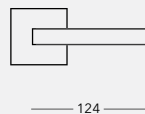

OCS **ONS**

	CZK	bez DPH	s DPH
BB/PZ	735.-	735.-	889.-
WC	950.-	950.-	1150.-
	EUR	bez DPH	s DPH
BB/PZ	31,3	31,3	37,5
WC	40,4	40,4	48,5



Esme-S

W 200 tis. **PR**

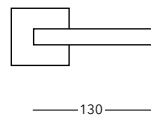

OCS **ONS**

	CZK	bez DPH	s DPH
BB/PZ	735.-	735.-	889.-
WC	950.-	950.-	1150.-
	EUR	bez DPH	s DPH
BB/PZ	31,3	31,3	37,5
WC	40,4	40,4	48,5



Spring-S

W **PR**

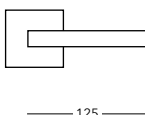

OCS **ONS**

	CZK	bez DPH	s DPH
BB/PZ	1015.-	1015.-	1228.-
WC	1230.-	1230.-	1488.-
	EUR	bez DPH	s DPH
BB/PZ	43,2	43,2	51,8
WC	52,3	52,3	62,8



Jerome-R

200 tis. KR

	bez DPH	s DPH
CZK		
BB/PZ	590.-	714.-
WC	700.-	847.-
PZ-LI/RE	755.-	914.-
EUR		
BB/PZ	25.1	30.1
WC	29.8	35.7
PZ-LI/RE	32.1	38.6

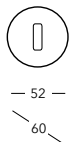
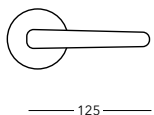

ocs

Laura

200 tis.

	bez DPH	s DPH
CZK		
BB/PZ	430.-	520.-
WC	530.-	641.-
PZ-LI/RE	590.-	714.-
EUR		
BB/PZ	18.3	22.0
WC	22.5	27.0
PZ-LI/RE	25.1	30.1

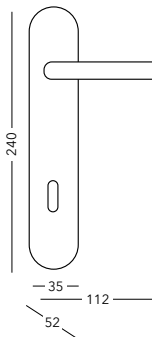

ocs ons olv ofs oc
eco

Laura-R

200 tis. KR

	bez DPH	s DPH
CZK		
BB/PZ	500.-	605.-
WC	610.-	738.-
PZ-LI/RE	665.-	805.-
EUR		
BB/PZ	21.3	25.5
WC	26.0	31.1
PZ-LI/RE	28.3	34.0

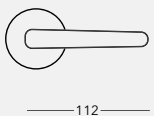

ocs ons olv ofs oc
eco

Mega-R

200 tis. KR

	bez DPH	s DPH
CZK		
BB/PZ	775.-	938.-
WC	885.-	1071.-
PZ-LI/RE	945.-	1143.-
EUR		
BB/PZ	33.0	39.6
WC	37.7	45.2
PZ-LI/RE	40.2	48.3

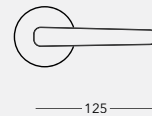

ocs

Mega-S

200 tis. KR

	bez DPH	s DPH
CZK		
BB/PZ	885.-	1071.-
WC	1000.-	1211.-
PZ-LI/RE	1060.-	1283.-
EUR		
BB/PZ	37.7	45.2
WC	42.6	51.1
PZ-LI/RE	45.1	54.1

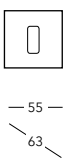
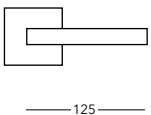

ocs

Milena

200 tis.

	bez DPH	s DPH
CZK		
BB/PZ	385.-	466.-
WC	500.-	605.-
PZ-LI/RE	550.-	666.-
EUR		
BB/PZ	16.4	19.7
WC	21.3	25.5
PZ-LI/RE	23.4	28.1

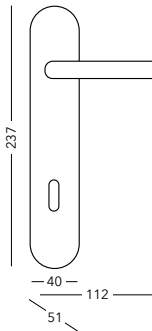

ocs ons ofs

Milena-R

W 200 tis. **KR**

	bez DPH	s DPH
CZK		
BB/PZ	425.-	514.-
WC	550.-	666.-
PZ-LI/RE	600.-	726.-

	bez DPH	s DPH
EUR		
BB/PZ	18,1	21,7
WC	23,4	28,1
PZ-LI/RE	25,5	30,6

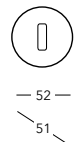
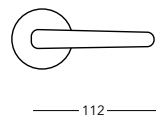

OCS ONS

Orion

W 200 tis.

	bez DPH	s DPH
CZK		
BB/PZ	385.-	466.-
WC	565.-	684.-
PZ-LI/RE	620.-	750.-

	bez DPH	s DPH
EUR		
BB/PZ	16,4	19,7
WC	24,0	28,9
PZ-LI/RE	26,4	31,7

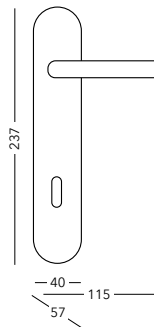

OCS ONS

Orion-R

W 200 tis. **KR**

	bez DPH	s DPH
CZK		
BB/PZ	520.-	629.-
WC	640.-	774.-
PZ-LI/RE	690.-	835.-

	bez DPH	s DPH
EUR		
BB/PZ	22,1	26,6
WC	27,2	32,7
PZ-LI/RE	29,4	35,2

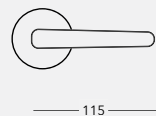

OCS ONS

Presso-S

W 200 tis. **KR**

	bez DPH	s DPH
CZK		
BB/PZ	735.-	889.-
WC	950.-	1150.-

	bez DPH	s DPH
EUR		
BB/PZ	31,3	37,5
WC	40,4	48,5

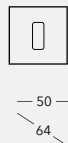
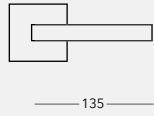

OCS ONS

Q-arte

W

	bez DPH	s DPH
CZK		
BB/PZ	1490.-	1803.-
WC	1790.-	2166.-
PZ-LI/RE	1890.-	2287.-

	bez DPH	s DPH
EUR		
BB/PZ	63,4	76,1
WC	76,2	91,4
PZ-LI/RE	80,4	96,5

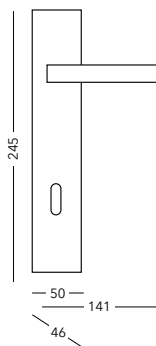

OCS ONS

Q-arte-S

W **KR**

	bez DPH	s DPH
CZK		
BB/PZ	1290.-	1561.-
WC	1690.-	2045.-

	bez DPH	s DPH
EUR		
BB/PZ	54,9	65,9
WC	71,9	86,3

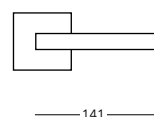

OCS ONS

865

1 mil. KR

🔑	CZK	bez DPH	s DPH
	BB/PZ	1275.-	1543.-
	WC	1595.-	1930.-
🔑	EUR	bez DPH	s DPH
	BB/PZ	54.3	65.1
	WC	67.9	81.4

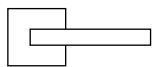

— 140 —



— 50 —
65



OCS ONS Černá

1145

1 mil. KR

🔑	CZK	bez DPH	s DPH
	BB/PZ	1485.-	1797.-
	WC	1700.-	2057.-
🔑	EUR	bez DPH	s DPH
	BB/PZ	63.2	75.8
	WC	72.3	86.8

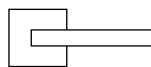

— 140 —



— 50 —
65



OCS ONS

1485

1 mil. KR

🔑	CZK	bez DPH	s DPH
	BB/PZ	950.-	1150.-
	WC	1380.-	1670.-
🔑	EUR	bez DPH	s DPH
	BB/PZ	40.4	48.5
	WC	58.7	70.5

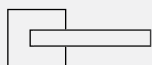

— 131 —



— 50 —
68



OCS OC

1495

1 mil. KR

🔑	CZK	bez DPH	s DPH
	BB/PZ	950.-	1150.-
	WC	1275.-	1543.-
🔑	EUR	bez DPH	s DPH
	BB/PZ	40.4	48.5
	WC	54.3	65.1



— 130,7 —



— 50 —
64



OCS ONS OC

1515

1 mil. KR

🔑	CZK	bez DPH	s DPH
	BB/PZ	950.-	1150.-
	WC	1380.-	1670.-
🔑	EUR	bez DPH	s DPH
	BB/PZ	40.4	48.5
	WC	58.7	70.5



— 143 —



— 50 —
53



OCS OC

1555

1 mil. KR

🔑	CZK	bez DPH	s DPH
	BB/PZ	1700.-	2057.-
	WC	2020.-	2444.-
🔑	EUR	bez DPH	s DPH
	BB/PZ	72.3	86.8
	WC	86.0	103.1

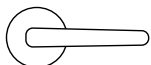

— 145 —



— 50 —
51



OCS ONS Černá

1505

1 mil. KR

	CZK	bez DPH	s DPH
BB/PZ	950.-	950.-	1150.-
WC	1380.-	1380.-	1670.-
EUR			
BB/PZ	40,4	40,4	48,5
WC	58,7	58,7	70,5

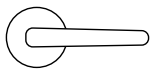

— 130,6 —



— 50 —

64



OCS OC

1535

1 mil. KR

	CZK	bez DPH	s DPH
BB/PZ	1165.-	1165.-	1410.-
WC	1380.-	1380.-	1670.-
EUR			
BB/PZ	49,6	49,6	59,5
WC	58,7	58,7	70,5

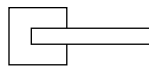

— 143 —



— 50 —

65



OCS ONS

Koule pevná Victory

KR

	CZK	bez DPH	s DPH
cena ks	430.-	430.-	520.-
EUR			
cena ks	18,3	18,3	22,0
obj. číslo	C415919602		

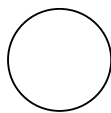

— Ø 55 —

65



OCS ONS OFS OCN

COBRA®

Samostatná koule bez rozety na vyžádání.
Varianty provedení levá, pravá, pevná, otočná.

ZÁRUKY

Za naše výrobky a služby ručíme. Na naše výrobky poskytujeme záruky v rozsahu od dvou do deseti let. Na kliky COBRA se můžete spolehnout.

ZÁRUKA AŽ 10 LET

Na naše designové kování Convex garantujeme minimálně 200 000 otevíracích a zavíracích cyklů a na všechny chromované produkty řady CONVEX poskytujeme 10 letou záruku proti jakýmkoli známám koroze.

www.cobra-cz.cz

GUARANTEES

Our products and services are guaranteed. We provide guarantees on our products ranging from two to ten years. COBRA handles can be relied on.

GUARANTEE UP TO 10 YEARS

With our design fitting Convex we guarantee minimum 200.000 opening and closing cycles and we also provide a 10- year - guarantee against any signs of corrosion on all chrome products in Convex line.

www.cobra-cz.cz





OC

Chrom lesklý

POLISHED CHROME

56 Alt-wien
56 Elegant
56 Laura

56 Laura-R
56 Orion-R
56 1485

57 1495
57 1505
57 1515





Chromové kliky pečlivě leštíme do vysokého lesku. Důraz klademe na vysokou kvalitu zpracování, protože lesklý povrch kliky nesnese sebemenší nedokonalost povrchu. Lesklý a studený „stříbrný“ odstín je vhodnou variantou do moderních světlých prostorů.

Chrome handles are polished into a glossy appearance. We put emphasis on high quality of processing as we know that shiny surface of the handle does not combine with any little imperfection of the surface. Glossy and cold “silver” shade is a very suitable choice for modern light areas.

Alt-wien

200 tis.

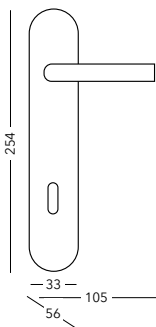

OCS OC ONS OFS OLV
OV K

	CZK	bez DPH	s DPH
BB/PZ	730.-	730.-	883.-
WC	930.-	930.-	1125.-
PZ-LI/RE	1010.-	1010.-	1222.-
EUR			
BB/PZ	31,1	31,1	37,3
WC	39,6	39,6	47,5
PZ-LI/RE	43,0	43,0	51,6

Elegant

200 tis.

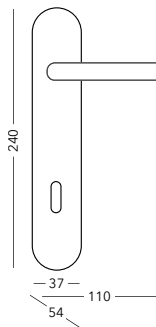

OCS OC ONS OFS OLV
OV K

	CZK	bez DPH	s DPH
BB/PZ	600.-	600.-	726.-
WC	745.-	745.-	901.-
PZ-LI/RE	815.-	815.-	986.-
EUR			
BB/PZ	25,5	25,5	30,6
WC	31,7	31,7	38,0
PZ-LI/RE	34,7	34,7	41,6

Laura

200 tis.

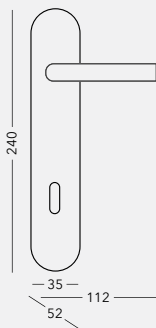

OCS OC ONS OFS OLV

	CZK	bez DPH	s DPH
BB/PZ	430.-	430.-	520.-
WC	530.-	530.-	641.-
PZ-LI/RE	590.-	590.-	714.-
EUR			
BB/PZ	18,3	18,3	22,0
WC	22,5	22,5	27,0
PZ-LI/RE	25,1	25,1	30,1

Laura-R

200 tis. KR



OCS OC ONS OFS OLV

	CZK	bez DPH	s DPH
BB/PZ	500.-	500.-	605.-
WC	610.-	610.-	738.-
PZ-LI/RE	665.-	665.-	805.-
EUR			
BB/PZ	21,3	21,3	25,5
WC	26,0	26,0	31,1
PZ-LI/RE	28,3	28,3	34,0

Orion-R

200 tis. KR

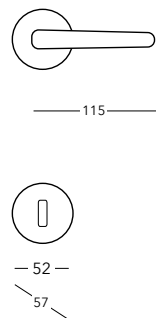

OCS OC ONS OFS OLV

	CZK	bez DPH	s DPH
BB/PZ	520.-	520.-	629.-
WC	640.-	640.-	774.-
PZ-LI/RE	690.-	690.-	835.-
EUR			
BB/PZ	22,1	22,1	26,6
WC	27,2	27,2	32,7
PZ-LI/RE	29,4	29,4	35,2

1485

1 mil. KR

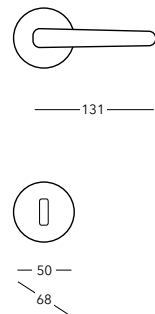

OCS OC

	CZK	bez DPH	s DPH
BB/PZ	1060.-	1060.-	1283.-
WC	1485.-	1485.-	1797.-
EUR			
BB/PZ	45,1	45,1	54,1
WC	63,2	63,2	75,8

1495

1 mil. KR

	CZK	bez DPH	s DPH
☞☞ BB/PZ		1015,-	1228,-
WC		1340,-	1621,-
☞☞ EUR		bez DPH	s DPH
☞☞ BB/PZ		43,2	51,8
WC		57,0	68,4

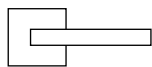

— 130,7 —



— 50 —

64



OCS OC ONS

1505

1 mil. KR

	CZK	bez DPH	s DPH
☞☞ BB/PZ		1060,-	1283,-
WC		1485,-	1797,-
☞☞ EUR		bez DPH	s DPH
☞☞ BB/PZ		45,1	54,1
WC		63,2	75,8



— 130,6 —



— 50 —

64



OC ONS

1515

1 mil. KR

OCS OC



— 143 —



— 50 —

53

	CZK	bez DPH	s DPH
☞☞ BB/PZ		1060,-	1283,-
WC		1425,-	1724,-
☞☞ EUR		bez DPH	s DPH
☞☞ BB/PZ		45,1	54,1
WC		60,6	72,8

BOHATÝ VÝBĚR

COBRA nabízí svým zákazníkům široký výběr druhů a tvarů kování v pestré škále materiálů a povrchových úprav. Výrobní řady jsou každoročně inovovány také s důrazem na design a styl. Tu správnou kliku si tak u značky COBRA vybere každý.

MODERNÍ DESIGN

Sledujeme nejmodernější trendy, ale nezapomínáme ani na tradiční hodnoty. Spolupracujeme se špičkovými designéry a nebojíme se nabídnout ani osobitá řešení. Neustále přinášíme stylové inovace v našich výrobních řadách, abychom zákazníkům nabídli vždy aktuální a moderní design.

www.cobra-cz.cz

WIDE RANGE OF PRODUCTS

COBRA offers a wide range of types and designs of fittings in many different materials and surface treatments. Product lines are innovated annually placing an emphasis on the design and style. Therefore everybody can make his choice with COBRA.

MODERN DESIGN

Although we follow the latest trends we also do not forget about traditional values. We cooperate with cutting-edge designers and we are not afraid to offer even more personal solutions. In our collections we keep bringing stylish innovations so that we can offer our customers up-to-date and modern design.

www.cobra-cz.cz

ONS

Níkl matný

SATIN NICKEL

60 Alexis	61 Elsa-S	63 Orion-R III	65 Zeus-R III
60 Alexis-R	62 Esme-S	63 Presso-S	66 865
60 Alt-Wien	62 Fap	64 Q-arte	66 1145
60 Aphrodité-S	62 Fap-R	64 Q-arte-S	66 1495
60 Athena-S	62 Laura	64 Sina	66 1535
60 Beata-S	62 Laura-R	64 Sina-R	66 1555
61 Denisa	62 Maja	64 Spring-S	
61 Denisa-R	63 Milena	64 Vega-S	66 Koule pevná
61 Elegant	63 Milena-R	65 Vera-S	Victory
61 Element	63 Orion	65 Zoe-R	
61 Element-R	63 Orion-R	65 Zeus	





Niklová klika v matné úpravě představuje jednu z nejoblíbenějších variant kování. Ohromí vás lehkými záblesky až do červené barvy a vyniknout téměř v každém moderním interiéru.

Nickel handle in frosted design represents one of the most popular types of fitting. You will be impressed with light flashes turning red, they will surely stand out in any modern interior.

Alexis

200 tis.

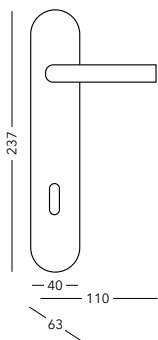

	bez DPH	s DPH
CZK		
BB/PZ	410,-	496,-
WC	520,-	629,-
PZ-LI/RE	580,-	702,-
EUR	bez DPH	s DPH
BB/PZ	17,4	20,9
WC	22,1	26,6
PZ-LI/RE	24,7	29,6



ONS

Alexis-R

200 tis. KR

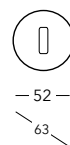
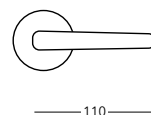

	bez DPH	s DPH
CZK		
BB/PZ	440,-	532,-
WC	550,-	666,-
PZ-LI/RE	610,-	738,-
EUR	bez DPH	s DPH
BB/PZ	18,7	22,5
WC	23,4	28,1
PZ-LI/RE	26,0	31,1



ONS OCS

Alt-Wien

200 tis.

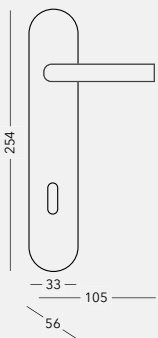

	bez DPH	s DPH
CZK		
BB/PZ	730,-	883,-
WC	930,-	1125,-
PZ-LI/RE	1010,-	1222,-
EUR	bez DPH	s DPH
BB/PZ	31,1	37,3
WC	39,6	47,5
PZ-LI/RE	43,0	51,6



OCS OC ONS OFS OLV
OV K

Aphrodité-S

200 tis. KR

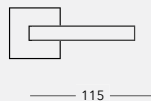

	bez DPH	s DPH
CZK		
BB/PZ	430,-	520,-
WC	540,-	653,-
EUR	bez DPH	s DPH
BB/PZ	18,3	22,0
WC	23,0	27,6

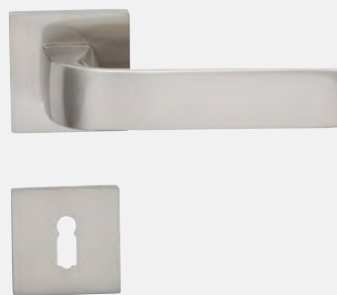

Titan ONS

Athena-S

200 tis. KR

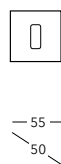
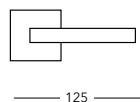

	bez DPH	s DPH
CZK		
BB/PZ	430,-	520,-
WC	540,-	653,-
EUR	bez DPH	s DPH
BB/PZ	18,3	22,0
WC	23,0	27,6

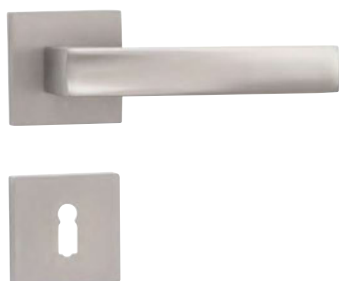

Titan ONS

Beata-S

200 tis. KR

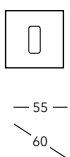
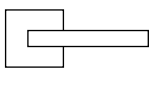

	bez DPH	s DPH
CZK		
BB/PZ	610,-	738,-
WC	720,-	871,-
PZ-LI/RE	775,-	938,-
EUR	bez DPH	s DPH
BB/PZ	26,0	31,1
WC	30,6	36,8
PZ-LI/RE	33,0	39,6



ONS

Denisa

200 tis.

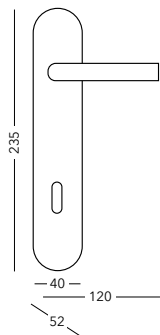

ONS

	CZK	bez DPH	s DPH
BB/PZ	325,-	325,-	393,-
WC	440,-	440,-	532,-
PZ-LI/RE	495,-	495,-	599,-

	EUR	bez DPH	s DPH
BB/PZ	13,8	13,8	16,6
WC	18,7	18,7	22,5
PZ-LI/RE	21,1	21,1	25,3

Denisa-R

200 tis. KR

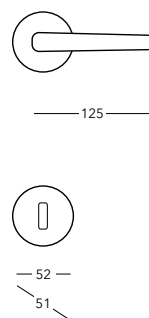

ONS

	CZK	bez DPH	s DPH
BB/PZ	360,-	360,-	436,-
WC	465,-	465,-	563,-
PZ-LI/RE	520,-	520,-	629,-

	EUR	bez DPH	s DPH
BB/PZ	15,3	15,3	18,4
WC	19,8	19,8	23,8
PZ-LI/RE	22,1	22,1	26,6

Elegant

200 tis.

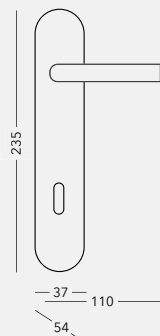

OLV OFS OC ONS OCS
K OV

	CZK	bez DPH	s DPH
BB/PZ	530,-	530,-	641,-
WC	675,-	675,-	817,-
PZ-LI/RE	745,-	745,-	901,-

	EUR	bez DPH	s DPH
BB/PZ	25,5	25,5	30,6
WC	31,7	31,7	38,0
PZ-LI/RE	34,7	34,7	41,6

Element

200 tis.

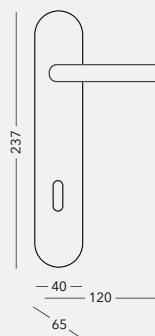

ONS F9 F4

	CZK	bez DPH	s DPH
BB/PZ	700,-	700,-	847,-
WC	813,-	813,-	984,-
PZ-LI/RE	865,-	865,-	1047,-

	EUR	bez DPH	s DPH
BB/PZ	29,8	29,8	35,7
WC	34,6	34,6	41,5
PZ-LI/RE	36,8	36,8	44,2

Element-R

200 tis. KR

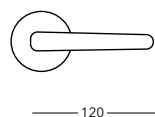

ONS

	CZK	bez DPH	s DPH
BB/PZ	701,-	701,-	848,-
WC	810,-	810,-	980,-
PZ-LI/RE	867,-	867,-	1049,-

	EUR	bez DPH	s DPH
BB/PZ	29,8	29,8	35,8
WC	34,5	34,5	41,4
PZ-LI/RE	36,9	36,9	44,3

Elsa-S

PR

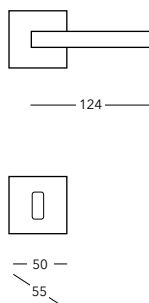

OCS ONS

	CZK	bez DPH	s DPH
BB/PZ	735,-	735,-	889,-
WC	950,-	950,-	1150,-

	EUR	bez DPH	s DPH
BB/PZ	31,3	31,3	37,5
WC	40,4	40,4	48,5

Esme-S

W PR ++

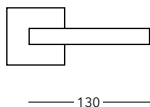

OCS ONS

	CZK	bez DPH	s DPH
🔑	BB/PZ	735,-	889,-
	WC	950,-	1150,-
🔑	EUR	bez DPH	s DPH
	BB/PZ	31,3	37,5
	WC	40,4	48,5



Fap

W 200 tis.

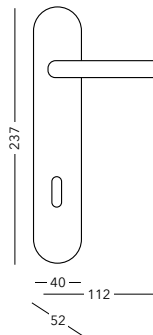

ONS

	CZK	bez DPH	s DPH
🔑	BB/PZ	440,-	532,-
	WC	550,-	666,-
🔑	PZ-LI/RE	610,-	738,-
🔑	EUR	bez DPH	s DPH
	BB/PZ	18,7	22,5
	WC	23,4	28,1
	PZ-LI/RE	26,0	31,1



Fap-R

W 200 tis. KR ++

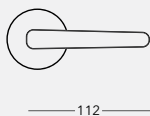

ONS

	CZK	bez DPH	s DPH
🔑	BB/PZ	530,-	641,-
	WC	640,-	774,-
🔑	PZ-LI/RE	700,-	847,-
🔑	EUR	bez DPH	s DPH
	BB/PZ	22,5	27,0
	WC	27,2	32,7
	PZ-LI/RE	29,8	35,7



Laura

W 200 tis.

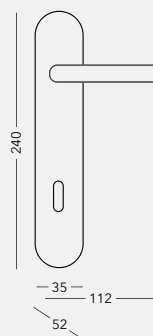

ONS OCS OC OFS OLV

	CZK	bez DPH	s DPH
🔑	BB/PZ	430,-	520,-
	WC	530,-	641,-
🔑	PZ-LI/RE	590,-	714,-
🔑	EUR	bez DPH	s DPH
	BB/PZ	18,3	22,0
	WC	22,5	27,0
	PZ-LI/RE	25,1	30,1



Laura-R

W 200 tis. KR ++

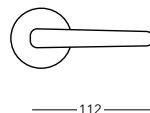

ONS OCS OC OLV OFS

ECO

	CZK	bez DPH	s DPH
🔑	BB/PZ	500,-	605,-
	WC	610,-	738,-
🔑	PZ-LI/RE	665,-	805,-
🔑	EUR	bez DPH	s DPH
	BB/PZ	21,3	25,5
	WC	26,0	31,1
	PZ-LI/RE	28,3	34,0



Maja

W 200 tis.

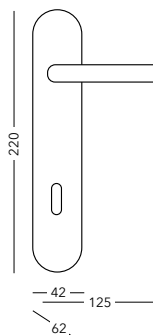

ONS

	CZK	bez DPH	s DPH
🔑	BB/PZ	385,-	466,-
	WC	500,-	605,-
🔑	PZ-LI/RE	515,-	623,-
🔑	EUR	bez DPH	s DPH
	BB/PZ	16,4	19,7
	WC	21,3	25,5
	PZ-LI/RE	21,9	26,3



Milena

200 tis.

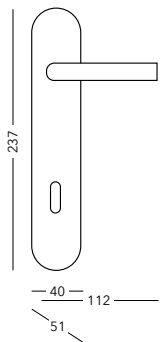

ONS OCS OFS



	CZK	bez DPH	s DPH
🔑 BB/PZ		385,-	466,-
🔑 WC		500,-	605,-
🔑 PZ-LI/RE		550,-	666,-
	EUR	bez DPH	s DPH
🔑 BB/PZ		16,4	19,7
🔑 WC		21,3	25,5
🔑 PZ-LI/RE		23,4	28,1

Milena-R

200 tis. KR

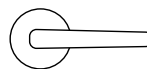

ONS OCS



	CZK	bez DPH	s DPH
🔑 BB/PZ		425,-	514,-
🔑 WC		550,-	666,-
🔑 PZ-LI/RE		600,-	726,-
	EUR	bez DPH	s DPH
🔑 BB/PZ		18,1	21,7
🔑 WC		23,4	28,1
🔑 PZ-LI/RE		25,5	30,6

Orion

200 tis.

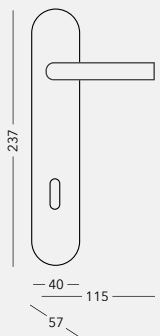

ONS OCS



	CZK	bez DPH	s DPH
🔑 BB/PZ		485,-	587,-
🔑 WC		600,-	726,-
🔑 PZ-LI/RE		655,-	793,-
	EUR	bez DPH	s DPH
🔑 BB/PZ		20,6	24,8
🔑 WC		25,5	30,6
🔑 PZ-LI/RE		27,9	33,4

Orion-R

200 tis. KR



ONS OCS



	CZK	bez DPH	s DPH
🔑 BB/PZ		520,-	629,-
🔑 WC		630,-	762,-
🔑 PZ-LI/RE		690,-	835,-
	EUR	bez DPH	s DPH
🔑 BB/PZ		22,1	26,6
🔑 WC		26,8	32,2
🔑 PZ-LI/RE		29,4	35,2

Orion-R III

200 tis. PR

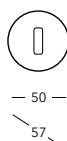
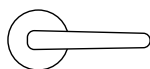

ONS



	CZK	bez DPH	s DPH
🔑 BB/PZ		335,-	405,-
🔑 WC		450,-	545,-
🔑 PZ-LI/RE		510,-	617,-
	EUR	bez DPH	s DPH
🔑 BB/PZ		14,3	17,1
🔑 WC		19,1	23,0
🔑 PZ-LI/RE		21,7	26,0

Presso-S

200 tis. KR

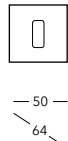
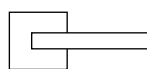

ONS OCS

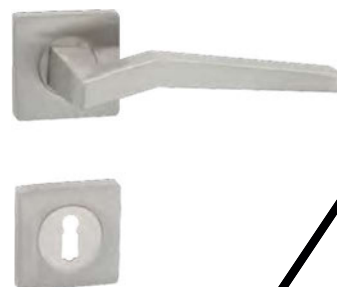

	CZK	bez DPH	s DPH
🔑 BB/PZ		1030,-	1246,-
🔑 WC		1135,-	1373,-
🔑 PZ-LI/RE		1190,-	1440,-
	EUR	bez DPH	s DPH
🔑 BB/PZ		43,8	52,6
🔑 WC		48,3	58,0
🔑 PZ-LI/RE		50,6	60,8

Q-arte

200 tis.

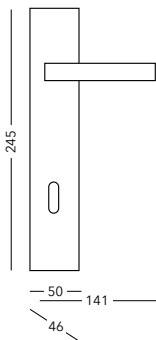

ONS OCS



	CZK	bez DPH	s DPH
BB/PZ	1595,-	1595,-	1930,-
WC	1915,-	1915,-	2318,-
PZ-LI/RE	2020,-	2020,-	2444,-
	EUR	bez DPH	s DPH
BB/PZ	67,9	67,9	81,4
WC	81,5	81,5	97,8
PZ-LI/RE	86,0	86,0	103,1

Q-arte-S

200 tis. KR



141



50

50

ONS OCS



	CZK	bez DPH	s DPH
BB/PZ	1290,-	1290,-	1561,-
WC	1690,-	1690,-	2045,-
	EUR	bez DPH	s DPH
BB/PZ	54,9	54,9	65,9
WC	71,9	71,9	86,3

Sina

200 tis.

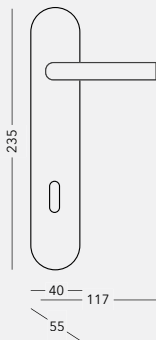

ONS OFS



	CZK	bez DPH	s DPH
BB/PZ	540,-	540,-	654,-
WC	655,-	655,-	793,-
PZ-LI/RE	710,-	710,-	859,-
	EUR	bez DPH	s DPH
BB/PZ	23,0	23,0	27,6
WC	27,9	27,9	33,4
PZ-LI/RE	30,2	30,2	36,3

Sina-R

200 tis. KR ++



110



52

58

ONS OFS



	CZK	bez DPH	s DPH
BB/PZ	710,-	710,-	859,-
WC	825,-	825,-	998,-
PZ-LI/RE	875,-	875,-	1059,-
	EUR	bez DPH	s DPH
BB/PZ	30,2	30,2	36,3
WC	35,1	35,1	42,1
PZ-LI/RE	37,2	37,2	44,7

Spring-S

200 tis. PR



125



52

59

OCS ONS



	CZK	bez DPH	s DPH
BB/PZ	950,-	950,-	1150,-
WC	1230,-	1230,-	1488,-
	EUR	bez DPH	s DPH
BB/PZ	43,2	43,2	51,8
WC	52,3	52,3	62,8

Vega-S

KR ++

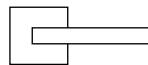

144



51

53

Černá ONS



	CZK	bez DPH	s DPH
BB/PZ	1100,-	1100,-	1331,-
WC	1300,-	1300,-	1573,-
	EUR	bez DPH	s DPH
BB/PZ	46,8	46,8	56,2
WC	55,3	55,3	66,4

Vera-S

W KR ↔

CZK	bez DPH	s DPH
BB/PZ	415.-	502.-
WC	480.-	581.-
EUR	bez DPH	s DPH
BB/PZ	17,7	21,2
WC	20,4	24,5



— 130 —



— 54 —
— 60 —



ONS OFS Černá

Zeus

W 200 tis.

CZK	bez DPH	s DPH
BB/PZ	355.-	430.-
WC	455.-	550.-
PZ-LI/RE	500.-	605.-
EUR	bez DPH	s DPH
BB/PZ	15,1	18,1
WC	19,4	23,2
PZ-LI/RE	21,3	25,5

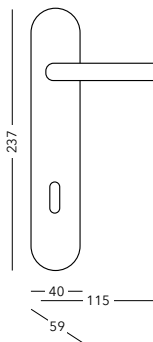

ONS



Zeus-R III

W 200 tis. PR ↔

CZK	bez DPH	s DPH
BB/PZ	375.-	453.-
WC	480.-	581.-
PZ-LI/RE	545.-	659.-
EUR	bez DPH	s DPH
BB/PZ	15,9	19,1
WC	20,4	24,5
PZ-LI/RE	23,2	27,8



— 115 —



— 52 —
— 57 —



ONS

Zoe-R

W 200 tis. KR ↔

CZK	bez DPH	s DPH
BB/PZ	385.-	466.-
WC	440.-	532.-
EUR	bez DPH	s DPH
BB/PZ	16,4	19,7
WC	18,7	22,5



— 146 —



— 52 —
— 59 —



ONS OFS IN Černá

865

W KR 1 mil.

CZK	bez DPH	s DPH
BB/PZ	1275.-	1543.-
WC	1595.-	1930.-
EUR	bez DPH	s DPH
BB/PZ	54,3	65,1
WC	67,9	81,4

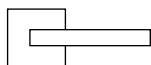

— 140 —



— 50 —
— 65 —



ONS OCS Černá

1145

W KR 1 mil.

CZK	bez DPH	s DPH
BB/PZ	1485.-	1797.-
WC	1595.-	1930.-
EUR	bez DPH	s DPH
BB/PZ	63,2	75,8
WC	67,9	81,4



— 140 —



— 50 —
— 65 —



ONS OCS

1495

KR 1 mil.

	CZK	bez DPH	s DPH
BB/PZ	950,-	950,-	1150,-
WC	1275,-	1275,-	1543,-
EUR			
BB/PZ	40,4	40,4	48,5
WC	54,3	54,3	65,1

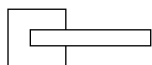

— 130,7 —



— 50 —

64

ONS OCS OC

**1535**

KR 1 mil.

	CZK	bez DPH	s DPH
BB/PZ	1165,-	1165,-	1410,-
WC	1380,-	1380,-	1670,-
EUR			
BB/PZ	49,6	49,6	59,5
WC	58,7	58,7	70,5



— 143 —



— 50 —

65

OCS ONS

**1555**

KR 1 mil.

	CZK	bez DPH	s DPH
BB/PZ	1700,-	1700,-	2057,-
WC	2020,-	2020,-	2444,-
EUR			
BB/PZ	72,3	72,3	86,8
WC	86,0	86,0	103,1



— 145 —



— 50 —

51

ONS OCS NIN

**Koule pevná
Victory**

KR

	CZK	bez DPH	s DPH
cena ks	430,-	430,-	520,-
EUR			
cena ks	18,3	18,3	22,0

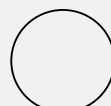

— Ø 52 —

59



OCS ONS OCN OFS

Samostatná koule bez rozety na vyžádání.
Zeptejte se na možnost otočných variant.

ČESKÁ FIRMA

Za našimi produkty a službami stojí bohaté zkušenosti a práce zaměstnanců stabilní české firmy. Pověstná zručnost a velké zkušenosti českých pracovníků jsou tak základem kvality a spolehlivosti výrobků značky COBRA.

TRADICE OD ROKU 1991

Jsmeme již 27let na trhu - od roku 1991 - a máme díky tomu bohaté zkušenosti. Známe potřeby našich zákazníků a trendy v oboru. To nám umožňuje neustále přinášet stále to nejlepší v našich výrobcích a službách.

www.cobra-cz.cz

CZECH COMPANY

Valuable experiences and work of our employees that is what lies behind products and services of COBRA. Reputation of having great skills and also experiences of our czech employees are the foundations of quality and reliability of COBRA products.

THIRTY YEARS OF TRADITION

We have thirty years of experience on interior design and door fittings market. We are aware of our customers' needs as well as the needs of architects and developers. Having this experience enables us to keep bringing the best in our products and services.

ONS





ČERNÁ TITAN

Černá / Titan

BLACK / TITANIUM

70	Aphrodité-S	70	Vega-S	71	Zoe-R
70	Athena-S	70	Vera-S	71	865
70	Linda-S	70	Vision-R III	71	1555



Nebojte se výrazného a netradičního řešení - elegantní černá klika v kombinaci s dalšími vhodně zvolenými prvky interiéru působí nejen luxusně, ale i velmi nadčasově.

Do not be afraid a distinctive and unconventional solution - elegant black handle in combination with a additional appropriately chosen elements of the interior can not only be luxurious but also very timeless.

Aphrodité-S

CZK	bez DPH	s DPH
BB/PZ	430,-	520,-
WC	540,-	653,-
EUR	bez DPH	s DPH
BB/PZ	18,3	22,0
WC	23,0	27,6

200 tis. KR

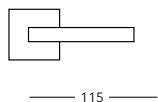

Titan ONS



Athena-S

CZK	bez DPH	s DPH
BB/PZ	430,-	520,-
WC	540,-	653,-
EUR	bez DPH	s DPH
BB/PZ	18,3	22,0
WC	23,0	27,6

200 tis. KR

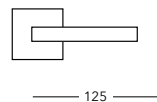

Titan ONS



Linda-S

CZK	bez DPH	s DPH
BB/PZ	830,-	1004,-
WC	935,-	1131,-
EUR	bez DPH	s DPH
BB/PZ	35,3	42,4
WC	39,8	47,7

KR



Černá



Vega-S

CZK	bez DPH	s DPH
BB/PZ	1100,-	1331,-
WC	1300,-	1573,-
EUR	bez DPH	s DPH
BB/PZ	46,8	56,2
WC	55,3	66,4

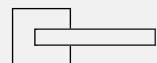

Černá ONS



Vera-s

CZK	bez DPH	s DPH
BB/PZ	515,-	623,-
WC	580,-	702,-
EUR	bez DPH	s DPH
BB/PZ	21,9	26,3
WC	24,7	29,6

200 tis. KR

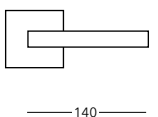

Černá ONS OFS



Vision-R III

CZK	bez DPH	s DPH
BB/PZ	570,-	690,-
WC	720,-	871,-
EUR	bez DPH	s DPH
BB/PZ	24,3	29,1
WC	30,6	36,8

200 tis. KR

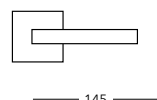

Černá IN



Zoe-R

W 200 tis. KR

	CZK	bez DPH	s DPH
BB/PZ	485,-	485,-	587,-
WC	540,-	540,-	653,-
EUR			
BB/PZ	20.6	20.6	24.8
WC	23.0	23.0	27.6



—140—



—50—
65



Cerná OFS ONS IN

865

W 1 mil. KR

	CZK	bez DPH	s DPH
BB/PZ	1275,-	1275,-	1543,-
WC	1595,-	1595,-	1930,-
EUR			
BB/PZ	54.3	54.3	65.1
WC	67.9	67.9	81.4

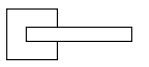

—140—



—50—
65



Cerná OCS ONS

1555

W 1 mil. KR

Cerná OCS ONS

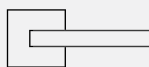

—145—



—50—
52

	CZK	bez DPH	s DPH
BB/PZ	1700,-	1700,-	2057,-
WC	2020,-	2020,-	2444,-
EUR			
BB/PZ	72.3	72.3	86.8
WC	86.0	86.0	103.1





OCN

Chrom lesklý / Nikl matný

POLISHED CHROME / SATIN NICKEL

74 Gabri
74 Gabri-R
74 Gabri-S
74 Giusy-R
74 Nicol-R

74 Nicol-S
75 Sharon-R
75 Sharon-S
75 Vanda-R

75 Koule pevná
Victory





Kombinované kliky představují skutečnou designovou lahůdku. Spojení lesklého chromu a matného niklu představuje unikátní řešení, spojující dva designové materiály do jednoho oku lahodícího funkčního celku.

Combined handles represent a real design delicacy. Merging of glossy chrome and frostal nickel is a unique solution joining two design materials into one nice-looking functional single unit.

Gabri

200 tis.

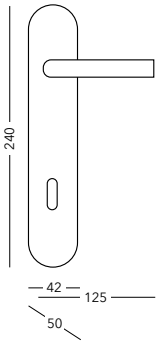

CZK		bez DPH	s DPH
BB/PZ	525.-	525.-	635.-
WC	765.-	765.-	926.-
PZ-LI/RE	720.-	720.-	871.-

EUR		bez DPH	s DPH
BB/PZ	22,3	22,3	26,8
WC	32,6	32,6	39,1
PZ-LI/RE	30,6	30,6	36,8



OCN

Gabri-S

200 tis. KR

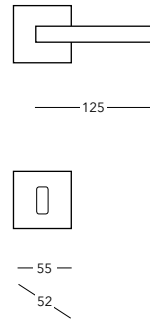

CZK		bez DPH	s DPH
BB/PZ	525.-	525.-	635.-
WC	765.-	765.-	926.-
PZ-LI/RE	945.-	945.-	1143.-

EUR		bez DPH	s DPH
BB/PZ	22,3	22,3	26,8
WC	32,6	32,6	39,1
PZ-LI/RE	40,2	40,2	48,3



OCN

Gabri-R

200 tis. KR

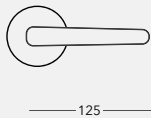

CZK		bez DPH	s DPH
BB/PZ	495.-	495.-	599.-
WC	740.-	740.-	895.-
PZ-LI/RE	740.-	740.-	895.-

EUR		bez DPH	s DPH
BB/PZ	21,1	21,1	25,3
WC	31,5	31,5	37,8
PZ-LI/RE	31,5	31,5	37,8



OCN

Giusy-R

200 tis. KR

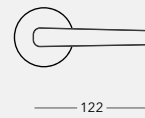

CZK		bez DPH	s DPH
BB/PZ	525.-	525.-	635.-
WC	765.-	765.-	926.-
PZ-LI/RE	825.-	825.-	998.-

EUR		bez DPH	s DPH
BB/PZ	22,3	22,3	26,8
WC	32,6	32,6	39,1
PZ-LI/RE	35,1	35,1	42,1



IN OCN OFS

Nicol-R

200 tis. PR

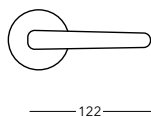

CZK		bez DPH	s DPH
BB/PZ	525.-	525.-	635.-
WC	655.-	655.-	793.-
PZ-LI/RE	825.-	825.-	998.-

EUR		bez DPH	s DPH
BB/PZ	22,3	22,3	26,8
WC	27,9	27,9	33,4
PZ-LI/RE	35,1	35,1	42,1



OCN

Nicol-S

200 tis. KR

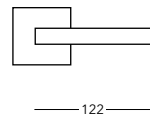

CZK		bez DPH	s DPH
BB/PZ	590.-	590.-	714.-
WC	770.-	770.-	932.-
PZ-LI/RE	935.-	935.-	1131.-

EUR		bez DPH	s DPH
BB/PZ	25,1	25,1	30,1
WC	32,8	32,8	39,3
PZ-LI/RE	39,8	39,8	47,7



OCN

Sharon-R

200 tis. KR

	CZK	bez DPH	s DPH
BB/PZ	775.-	775.-	938.-
WC	890.-	890.-	1077.-
PZ-LI/RE	945.-	945.-	1143.-
	EUR	bez DPH	s DPH
BB/PZ	33.0	33.0	39.6
WC	37.9	37.9	45.4
PZ-LI/RE	40.2	40.2	48.3

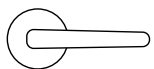

135



52

68



OCN

Sharon-S

200 tis. KR

	CZK	bez DPH	s DPH
BB/PZ	890.-	890.-	1077.-
WC	1000.-	1000.-	1211.-
PZ-LI/RE	1060.-	1060.-	1283.-
	EUR	bez DPH	s DPH
BB/PZ	37.9	37.9	45.4
WC	42.6	42.6	51.1
PZ-LI/RE	45.1	45.1	54.1

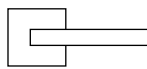

135



55

68



OCN

Vanda-R

200 tis. KR

	CZK	bez DPH	s DPH
BB	415.-	415.-	502.-
WC	480.-	480.-	581.-
LI/RE	590.-	590.-	714.-
	EUR	bez DPH	s DPH
BB	17.7	17.7	21.2
WC	20.4	20.4	24.5
LI/RE	25.1	25.1	30.1



120



52

60



OCN

Koule pevná Victory

200 tis. KR

	CZK	bez DPH	s DPH
cena ks	430.-	430.-	520.-
	EUR	bez DPH	s DPH
cena ks	18.3	18.3	22.0
obj. číslo	C415917602		

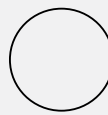

Ø52

59



OCN ONS OCN OFS

Samostatná koule bez rozety na vyžádání.
Varianty provedení levá, pravá, pevná, otočná.





OFS

Bronz česaný

BRUSHED BRASS

78	Alt-Wien	79	Kristina	80	Venezia
78	Atlantis	79	Kristina-R	80	Vera-S
78	Dea	79	Laura	81	Zoe-R
78	Dea-R	79	Laura-R		
78	Elegant	80	Milena	81	Koule pevná
78	Florence	80	Münster		Victory
79	Gussy-R	80	Sina		
79	Ikarus	80	Sina-R		





Česaný bronz díky své jedinečné barevnosti a struktuře patří mezi nejoblíbenější výrobky COBRA. Dveřní kování v tradičních i moderních tvarech působí zcela unikátně, doslova číší tajemnem starých časů..

Thanks to its unique variety of colour and its structure. Brushed brass belongs among the most popular COBRA products. Door fittings in traditional and modern shapes look very unique literally overflowing with old time's mystery.

Alt-Wien

W 200 tis.

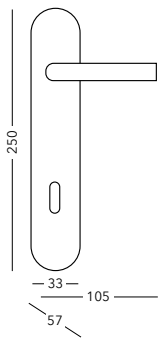

	CZK	bez DPH	s DPH
🔑 BB/PZ		660.-	799.-
🔑 WC		810.-	980.-
🔑 PZ-LI/RE		885.-	1071.-
	EUR	bez DPH	s DPH
🔑 BB/PZ		28.1	33.7
🔑 WC		34.5	41.4
🔑 PZ-LI/RE		37.7	45.2



OLV OFS OC ONS OCS
K OV

Atlantis

W 200 tis.

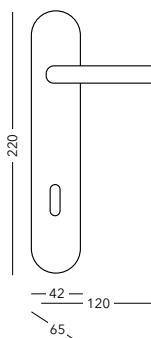

	CZK	bez DPH	s DPH
🔑 BB/PZ		890.-	1077.-
🔑 WC		1000.-	1211.-
🔑 PZ-LI/RE		1060.-	1283.-
	EUR	bez DPH	s DPH
🔑 BB/PZ		37.9	45.4
🔑 WC		42.6	51.1
🔑 PZ-LI/RE		45.1	54.1



OLV OFS K

Dea

W 200 tis.

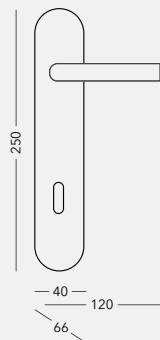

	CZK	bez DPH	s DPH
🔑 BB/PZ		665.-	805.-
🔑 WC		775.-	938.-
🔑 PZ-LI/RE		835.-	1010.-
	EUR	bez DPH	s DPH
🔑 BB/PZ		28.3	34.0
🔑 WC		33.0	39.6
🔑 PZ-LI/RE		35.5	42.6



OFS

Dea-R

W 200 tis. KR



	CZK	bez DPH	s DPH
🔑 BB/PZ		720.-	871.-
🔑 WC		835.-	1010.-
🔑 PZ-LI/RE		885.-	1071.-
	EUR	bez DPH	s DPH
🔑 BB/PZ		30.6	36.8
🔑 WC		35.5	42.6
🔑 PZ-LI/RE		37.7	45.2



OFS

Elegant

W 200 tis.

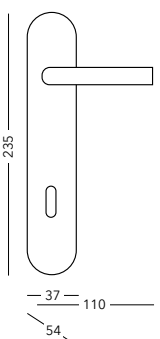

	CZK	bez DPH	s DPH
🔑 BB/PZ		530.-	641.-
🔑 WC		675.-	817.-
🔑 PZ-LI/RE		745.-	901.-
	EUR	bez DPH	s DPH
🔑 BB/PZ		22.5	27.0
🔑 WC		28.7	34.5
🔑 PZ-LI/RE		31.7	38.0



OLV OFS OC ONS OCS
K OV

Florence

W 200 tis.

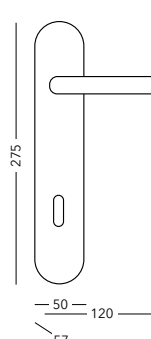

	CZK	bez DPH	s DPH
🔑 BB/PZ		875.-	1059.-
🔑 WC		990.-	1198.-
🔑 PZ-LI/RE		1045.-	1264.-
	EUR	bez DPH	s DPH
🔑 BB/PZ		37.2	44.7
🔑 WC		42.1	50.5
🔑 PZ-LI/RE		44.5	53.4



OFS

Giussy-R

200 tis. KR

	bez DPH	s DPH
CZK		
BB/PZ	525.-	635.-
WC	765.-	926.-
PZ-LI/RE	825.-	998.-
EUR	bez DPH	s DPH
BB/PZ	22,3	26,8
WC	32,6	39,1
PZ-LI/RE	35,1	42,1

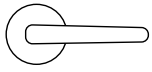

122



52
68



IN OFS OCN F1 F4

Ikarus

200 tis.

	bez DPH	s DPH
CZK		
BB/PZ	645.-	780.-
WC	850.-	1029.-
PZ-LI/RE	925.-	1119.-
EUR	bez DPH	s DPH
BB/PZ	27,4	32,9
WC	36,2	43,4
PZ-LI/RE	39,4	47,2

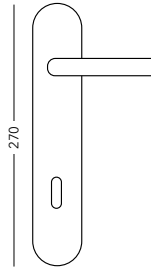

270

38 120

38



OLV OFS

Kristina

200 tis.

	bez DPH	s DPH
CZK		
BB/PZ	475.-	575.-
WC	590.-	714.-
PZ-LI/RE	640.-	774.-
EUR	bez DPH	s DPH
BB/PZ	20,2	24,3
WC	25,1	30,1
PZ-LI/RE	27,2	32,7

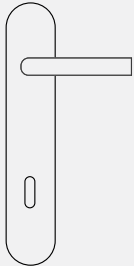

40 108

49



OFS OLV

Kristina-R

200 tis. KR

	bez DPH	s DPH
CZK		
BB/PZ	540.-	654.-
WC	655.-	793.-
PZ-LI/RE	710.-	859.-
EUR	bez DPH	s DPH
BB/PZ	23,0	27,6
WC	27,9	33,4
PZ-LI/RE	30,2	36,3

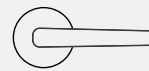

108



52
49



OLV OFS

Laura

200 tis.

	bez DPH	s DPH
CZK		
BB/PZ	430.-	520.-
WC	530.-	641.-
PZ-LI/RE	590.-	714.-
EUR	bez DPH	s DPH
BB/PZ	18,3	22,0
WC	22,5	27,0
PZ-LI/RE	25,1	30,1

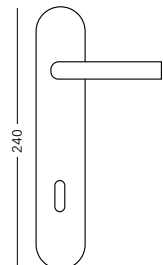

240

35 112

52



ONS OCS OC OLV OFS

Laura-R

200 tis. KR

	bez DPH	s DPH
CZK		
BB/PZ	500.-	605.-
WC	610.-	738.-
PZ-LI/RE	665.-	805.-
EUR	bez DPH	s DPH
BB/PZ	21,3	25,5
WC	26,0	31,1
PZ-LI/RE	28,3	34,0

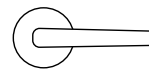

112



52
54



ONS OCS OC OLV OFS

Milena

W 200 tis.

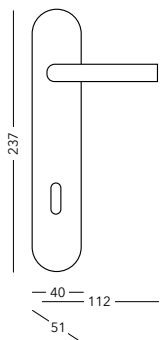

ONS OCS OFS



	bez DPH	s DPH
CZK		
BB/PZ	385,-	466,-
WC	500,-	605,-
PZ-LI/RE	550,-	666,-
EUR		
BB/PZ	16,4	19,7
WC	21,3	25,5
PZ-LI/RE	23,4	28,1

Münster

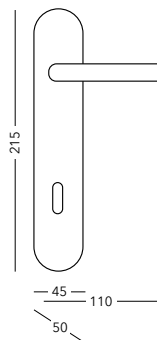

OLV OFS



	bez DPH	s DPH
CZK		
BB/PZ	375,-	453,-
WC	485,-	587,-
PZ-LI/RE	540,-	654,-
EUR		
BB/PZ	15,9	19,1
WC	20,6	24,8
PZ-LI/RE	23,0	27,6

Sina

W 200 tis.

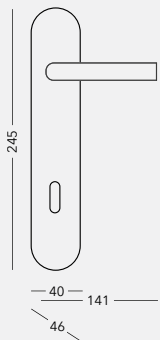

OFS ONS



	bez DPH	s DPH
CZK		
BB/PZ	540,-	654,-
WC	655,-	793,-
PZ-LI/RE	710,-	859,-
EUR		
BB/PZ	23,0	27,6
WC	27,9	33,4
PZ-LI/RE	30,2	36,3

Sina-R

W 200 tis. **++ KR**



ONS OFS



	bez DPH	s DPH
CZK		
BB/PZ	710,-	859,-
WC	825,-	998,-
PZ-LI/RE	875,-	1059,-
EUR		
BB/PZ	30,2	36,3
WC	35,1	42,1
PZ-LI/RE	37,2	44,7

Venezia

W 200 tis.

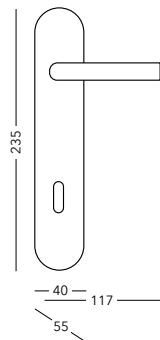

OFS K



	bez DPH	s DPH
CZK		
BB/PZ	540,-	654,-
WC	655,-	793,-
PZ-LI/RE	710,-	859,-
EUR		
BB/PZ	23,0	27,6
WC	27,9	33,4
PZ-LI/RE	30,2	36,3

Vera-S

W 200 tis. **++ KR**

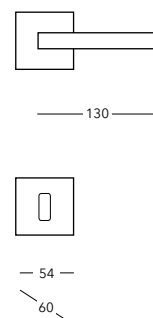

ONS OFS Černá



	bez DPH	s DPH
CZK		
BB/PZ	415,-	502,-
WC	480,-	581,-
EUR		
BB/PZ	17,7	21,2
WC	20,4	24,5

Zoe-R

200 tis. KR

CZK	bez DPH	s DPH
BB/PZ	385,-	466,-
WC	440,-	532,-
EUR	bez DPH	s DPH
BB/PZ	16,4	19,7
WC	18,7	22,5

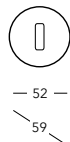
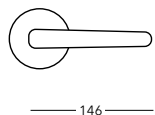

ONS OFS IN



Koule pevná Victory

KR

CZK	bez DPH	s DPH
cena ks	430,-	520,-
EUR	bez DPH	s DPH
cena ks	18,3	22,0

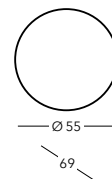

OCS ONS OFS OLV OC

Samostatná koule bez rozety na vyžádání.
Varianty provedení levá, pravá, pevná, otočná.

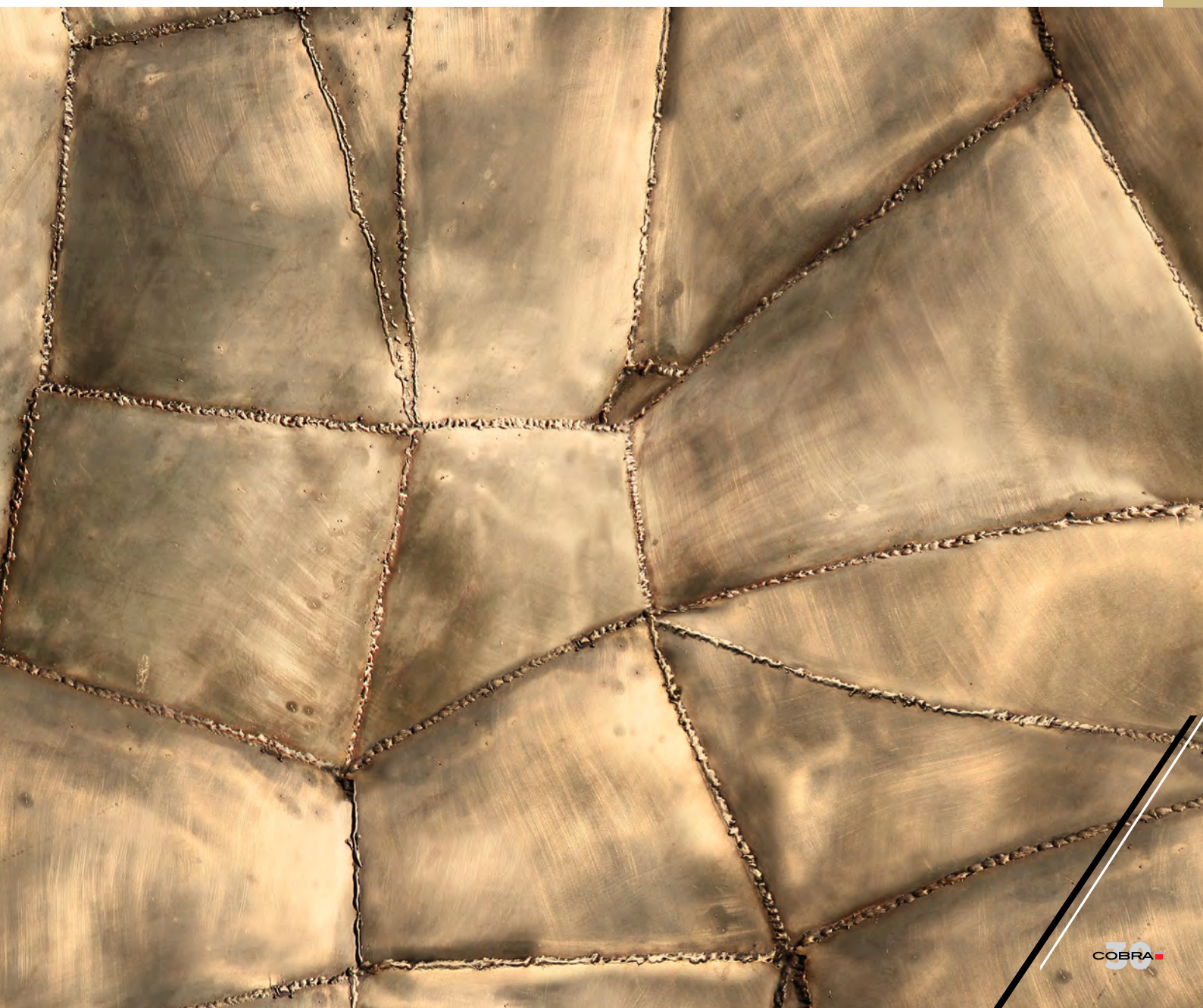



COLV

Mosaz leštěná

POLISH BRASS

84 Alt-Wien
84 Atlantis
84 Elegant

84 Ikarus
84 Kristina
84 Kristina-R

85 Laura
85 Laura-R
85 Münster





Mosazné kliky strojně leštíme, abychom dosáhli nejvyššího lesku. Při zpracování klademe nejvyšší nároky na kvalitu, zlatý vzhled kliky totiž nesnese sebemenší chybu v lesku.

Brass handles are mechanically polished in order to reach the best shine possible. During processing we place emphasis on quality. The golden appearance of the handle does not pardon even the smallest defect on the gloss.

Alt-Wien

200 tis.

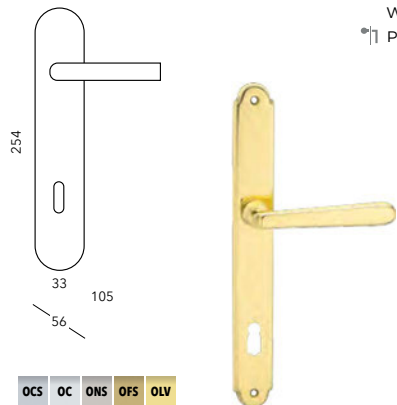

OCS OC ONS OFS OLV
OV K

	CZK	bez DPH	s DPH
🔑 BB/PZ		660.-	799.-
🔑 WC		810.-	980.-
🔑 PZ-LI/RE		885.-	1071.-
	EUR	bez DPH	s DPH
🔑 BB/PZ		28,1	33,7
🔑 WC		34,5	41,4
🔑 PZ-LI/RE		37,7	45,2

Atlantis

200 tis.



OFS OLV K

	CZK	bez DPH	s DPH
🔑 BB/PZ		890.-	1077.-
🔑 WC		1000.-	1211.-
🔑 PZ-LI/RE		1060.-	1283.-
	EUR	bez DPH	s DPH
🔑 BB/PZ		37,9	45,4
🔑 WC		42,6	51,1
🔑 PZ-LI/RE		45,1	54,1

Elegant

200 tis.

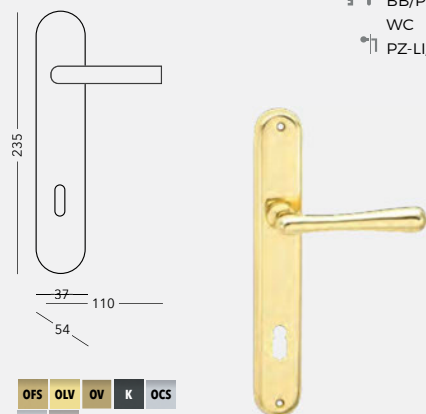

OFS OLV OV K OCS
OC ONS

	CZK	bez DPH	s DPH
🔑 BB/PZ		530.-	641.-
🔑 WC		675.-	817.-
🔑 PZ-LI/RE		745.-	901.-
	EUR	bez DPH	s DPH
🔑 BB/PZ		22,5	27,0
🔑 WC		28,7	34,5
🔑 PZ-LI/RE		31,7	38,0

Ikarus

200 tis.

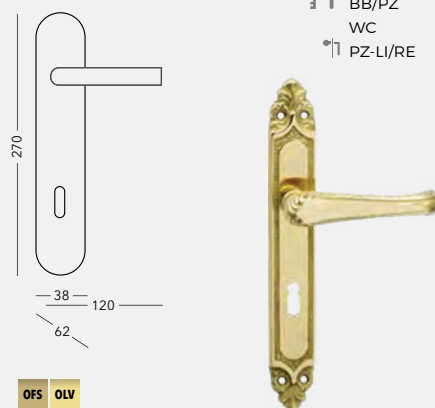

OFS OLV

	CZK	bez DPH	s DPH
🔑 BB/PZ		645.-	780.-
🔑 WC		850.-	1029.-
🔑 PZ-LI/RE		925.-	1119.-
	EUR	bez DPH	s DPH
🔑 BB/PZ		27,4	32,9
🔑 WC		36,2	43,4
🔑 PZ-LI/RE		39,4	47,2

Kristina

200 tis. PR

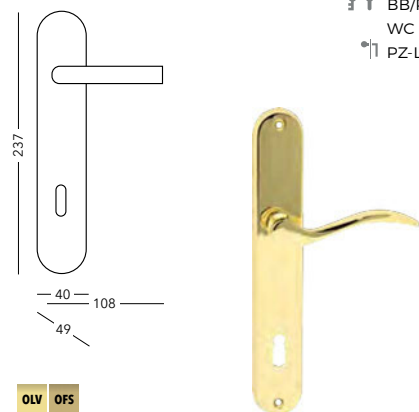

OLV OFS

	CZK	bez DPH	s DPH
🔑 BB/PZ		475.-	575.-
🔑 WC		590.-	714.-
🔑 PZ-LI/RE		640.-	774.-
	EUR	bez DPH	s DPH
🔑 BB/PZ		20,2	24,3
🔑 WC		25,1	30,1
🔑 PZ-LI/RE		27,2	32,7

Kristina-R

200 tis. KR ++

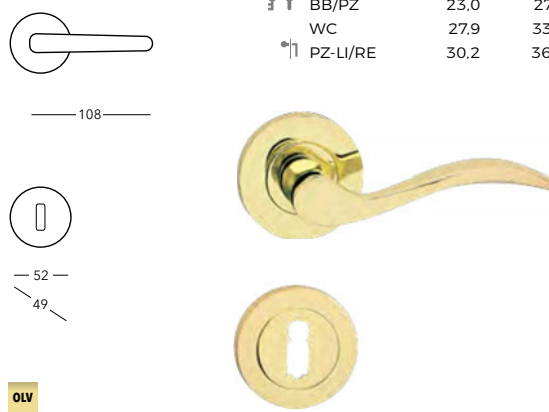

OLV

	CZK	bez DPH	s DPH
🔑 BB/PZ		540.-	654.-
🔑 WC		655.-	793.-
🔑 PZ-LI/RE		710.-	859.-
	EUR	bez DPH	s DPH
🔑 BB/PZ		23,0	27,6
🔑 WC		27,9	33,4
🔑 PZ-LI/RE		30,2	36,3

Laura

W 200 tis.

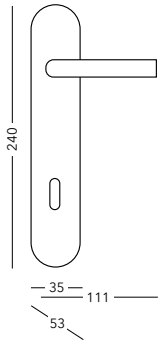

OCS OC ONS OFS OLV

	CZK	bez DPH	s DPH
🔑 BB/PZ		430,-	520,-
🚻 WC		530,-	641,-
🚪 PZ-LI/RE		590,-	714,-
	EUR	bez DPH	s DPH
🔑 BB/PZ		18,3	22,0
🚻 WC		22,5	27,0
🚪 PZ-LI/RE		25,1	30,1



Laura-R

W 200 tis. **KR**

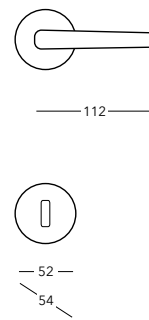

OCS OC ONS OFS OLV

	CZK	bez DPH	s DPH
🔑 BB/PZ		500,-	605,-
🚻 WC		610,-	738,-
🚪 PZ-LI/RE		665,-	805,-
	EUR	bez DPH	s DPH
🔑 BB/PZ		21,3	25,5
🚻 WC		26,0	31,1
🚪 PZ-LI/RE		28,3	34,0



Münster

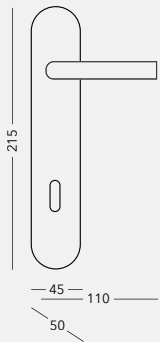

OFS OLV

	CZK	bez DPH	s DPH
🔑 BB/PZ		375,-	453,-
🚻 WC		485,-	587,-
🚪 PZ-LI/RE		540,-	654,-
	EUR	bez DPH	s DPH
🔑 BB/PZ		15,9	19,1
🚻 WC		20,6	24,8
🚪 PZ-LI/RE		23,0	27,6





OV

Staromosaz

OLD BRASS

87 Alt-wien

87 Elegant

Decentní matný vzhled staromosazných klik je krásný v kombinaci s tradičními prvky rustikálních interiérů. Klasika, to je ten správný výraz pro charakter staromosazných dveřních kování.

Decent frostal look of ancient brass handles is very beautiful if put in combination with traditional elements of rustic-looking interiors. A "classic" that is the correct name for character of old brass door fittings.

Alt-wien

200 tis.

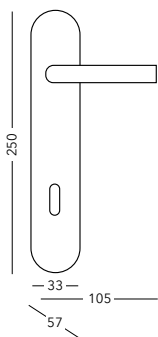

OCS OC ONS OFS OLV
OV K



CZK		bez DPH	s DPH
☞☞	BB/PZ	660,-	799,-
	WC	810,-	980,-
☞	PZ-LI/RE	885,-	1071,-

EUR		bez DPH	s DPH
☞☞	BB/PZ	28,1	33,7
	WC	34,5	41,4
☞	PZ-LI/RE	37,7	45,2

Elegant

200 tis.

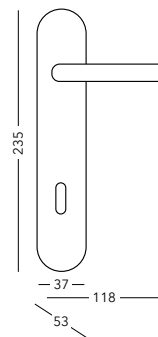

OCS OC ONS OFS OLV
OV K



CZK		bez DPH	s DPH
☞☞	BB/PZ	530,-	641,-
	WC	675,-	817,-
☞	PZ-LI/RE	745,-	901,-

EUR		bez DPH	s DPH
☞☞	BB/PZ	22,5	27,0
	WC	28,7	34,5
☞	PZ-LI/RE	31,7	38,0





Kované a rustikální kování

FORGED HARDWARE

90	Alt-Wien	91	Elegant	93	Venezia
90	Atlantis	92	Hamburg	93	Venezia-R
90	Atlantis-R	92	Hamburg-R	94	Vienna-R+
90	Baden	92	Hamburg-R+		
90	Baden+	92	Imst+	94	Koule pevná
90	Baden-S	92	Imst-R		Bonn HR
91	Baden-S+	92	Innsbruck		
91	Berlin	93	Innsbruck-R	94	Koule pevná
91	Bremen	93	Regen		Linz HR
91	Burg	93	Salzburg		
91	Burg-R	93	Salzburg-S		



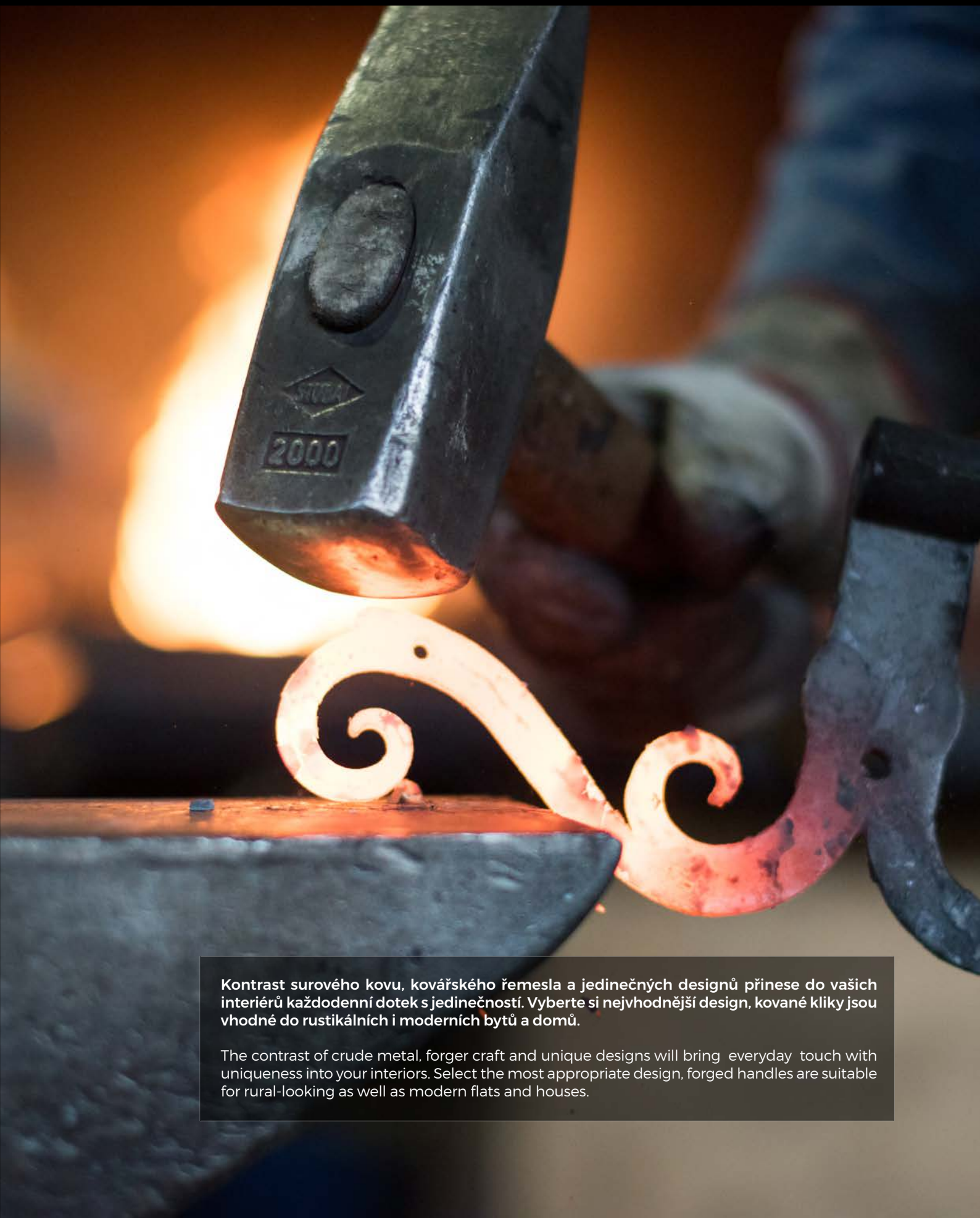

Kontrast surového kovu, kovářského řemesla a jedinečných designů přinese do vašich interiérů každodenní dotek s jedinečností. Vyberte si nejvhodnější design, kované kliky jsou vhodné do rustikálních i moderních bytů a domů.

The contrast of crude metal, forger craft and unique designs will bring everyday touch with uniqueness into your interiors. Select the most appropriate design, forged handles are suitable for rural-looking as well as modern flats and houses.

Alt-Wien

rustikální

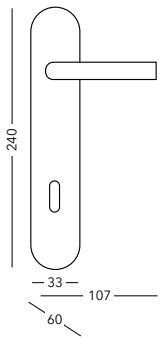

CZK	bez DPH	s DPH
BB/PZ	660.-	799.-
WC	810.-	980.-
PZ-LI/RE	885.-	1071.-

EUR	bez DPH	s DPH
BB/PZ	28,1	33,7
WC	34,5	41,4
PZ-LI/RE	37,7	45,2



OCS OC ONS OFS OLV
OV K

Atlantis

rustikální

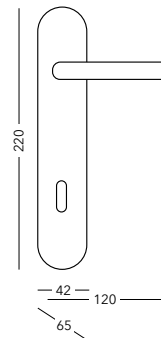

CZK	bez DPH	s DPH
BB/PZ	695.-	841.-
WC	1000.-	1211.-
PZ-LI/RE	1060.-	1283.-

EUR	bez DPH	s DPH
BB/PZ	29,6	35,5
WC	42,6	51,1
PZ-LI/RE	45,1	54,1



OFS OLV K

Atlantis-R

rustikální

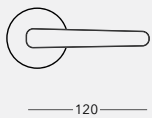

CZK	bez DPH	s DPH
BB/PZ	740.-	895.-
WC	1055.-	1277.-
PZ-LI/RE	1115.-	1349.-

EUR	bez DPH	s DPH
BB/PZ	31,5	37,8
WC	44,9	53,9
PZ-LI/RE	47,4	56,9



K

Baden

CZK	bez DPH	s DPH
BB/PZ	3250.-	3933.-
WC	4160.-	5034.-
PZ-LI/RE	3660.-	4429.-

EUR	bez DPH	s DPH
BB/PZ	138,3	166,0
WC	177,0	212,4
PZ-LI/RE	155,7	186,9

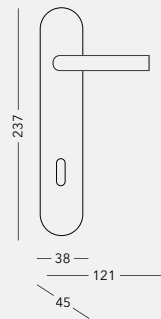

K

Baden+

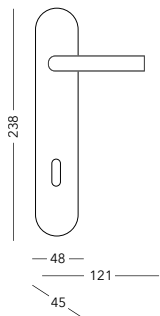

CZK	bez DPH	s DPH
PZ-LI/RE	5385.-	6516.-

EUR	bez DPH	s DPH
PZ-LI/RE	229,1	275,0



K

Baden-S

CZK	bez DPH	s DPH
BB/PZ	3235.-	3914.-
WC	4170.-	5046.-

EUR	bez DPH	s DPH
BB/PZ	137,7	165,2
WC	177,4	212,9

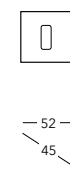
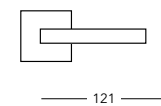

K

Baden-S+

CZK	bez DPH	s DPH
🔑 PZ-LI/RE	4785,-	5790,-

EUR	bez DPH	s DPH
🔑 PZ-LI/RE	203,6	244,3

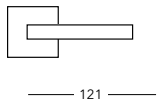

Berlin

CZK	bez DPH	s DPH
🔑 BB/PZ	2345,-	2837,-
🔑 PZ-LI/RE	2450,-	2965,-

EUR	bez DPH	s DPH
🔑 BB/PZ	99,8	119,7
🔑 PZ-LI/RE	104,3	125,1

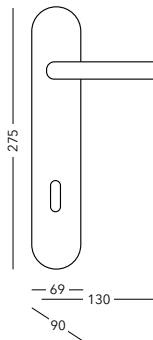

Bremen

CZK	bez DPH	s DPH
🔑 BB/PZ	1170,-	1416,-
🔑 PZ-LI/RE	1460,-	1767,-

EUR	bez DPH	s DPH
🔑 BB/PZ	49,8	59,7
🔑 PZ-LI/RE	62,1	74,6

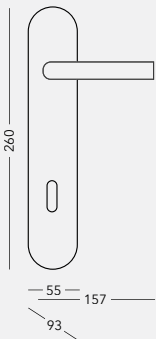

Burg

CZK	bez DPH	s DPH
🔑 BB/PZ	2735,-	3309,-
WC	3560,-	4308,-
🔑 PZ-LI/RE	3100,-	3751,-

EUR	bez DPH	s DPH
🔑 BB/PZ	116,4	139,7
WC	151,5	181,8
🔑 PZ-LI/RE	131,9	158,3

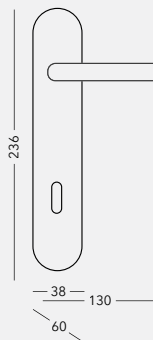

Burg-R

CZK	bez DPH	s DPH
🔑 BB/PZ	2720,-	3291,-
WC	3565,-	4314,-

EUR	bez DPH	s DPH
🔑 BB/PZ	115,7	138,9
WC	151,7	182,0

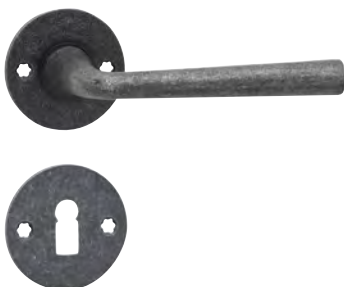
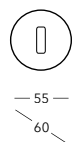
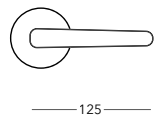

Elegant

rustikální

CZK	bez DPH	s DPH
🔑 BB/PZ	530,-	641,-
WC	675,-	817,-
🔑 PZ-LI/RE	745,-	901,-

EUR	bez DPH	s DPH
🔑 BB/PZ	22,5	27,0
WC	28,7	34,5
🔑 PZ-LI/RE	31,7	38,0

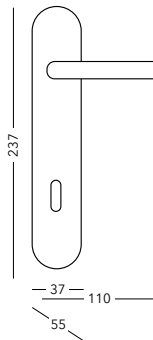

Hamburg

CZK		bez DPH	s DPH
🔑	BB/PZ	1700,-	2057,-
🔑	PZ-LI/RE	1915,-	2318,-
EUR		bez DPH	s DPH
🔑	BB/PZ	72.3	86.8
🔑	PZ-LI/RE	81.5	97.8

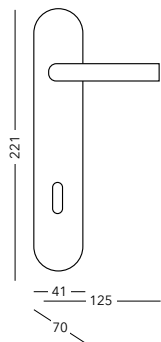

K

Hamburg-R

CZK		bez DPH	s DPH
🔑	BB/PZ	1880,-	2275,-
🔑	WC	2105,-	2547,-
EUR		bez DPH	s DPH
🔑	BB/PZ	80.0	96.0
🔑	WC	89.6	107.5

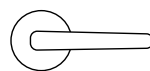

— 125 —



— 52 —
— 63 —



K

Hamburg-R+

CZK		bez DPH	s DPH
🔑	PZ	2870,-	3473,-
EUR		bez DPH	s DPH
🔑	PZ	122.1	146.6

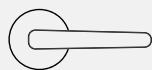

— 140 —



— 60 —
— 70 —



K

Imst+

CZK		bez DPH	s DPH
🔑	PZ	3245	3926
🔑	PZ-LI/RE	3245	3926
EUR		bez DPH	s DPH
🔑	PZ	138.1	165.7
🔑	PZ-LI/RE	138.1	165.7

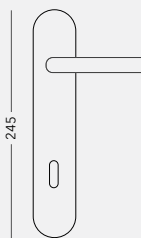

— 52 —
— 130 —
— 76 —



K

Imst-R

CZK		bez DPH	s DPH
🔑	BB/PZ	990	1198
🔑	PZ-LI/RE	1665	2015
EUR		bez DPH	s DPH
🔑	BB/PZ	42.1	50.5
🔑	PZ-LI/RE	70.9	85.0

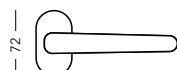

— 130 —



— 30 —
— 68 —



K

Innsbruck

CZK		bez DPH	s DPH
🔑	BB/PZ	2835,-	3430,-
🔑	WC	3660,-	4429,-
🔑	PZ-LI/RE	3195,-	3866,-
EUR		bez DPH	s DPH
🔑	BB/PZ	120.6	144.8
🔑	WC	155.7	186.9
🔑	PZ-LI/RE	135.9	163.0

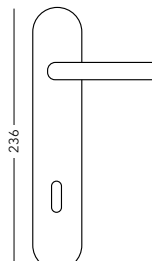

— 38 —
— 120 —
— 62 —



K

Innsbruck-R

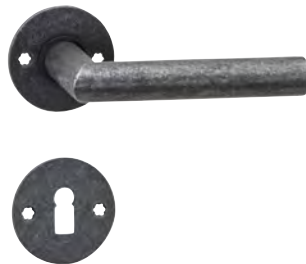
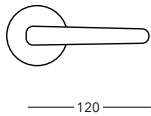

	bez DPH	s DPH
CZK		
🔑 BB/PZ	2820,-	3412,-
🔑 WC	3670,-	4441,-

	bez DPH	s DPH
EUR		
🔑 BB/PZ	120,0	144,0
🔑 WC	156,2	187,4

K

Regen

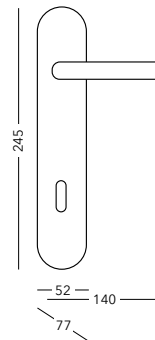

	bez DPH	s DPH
CZK		
🔑 PZ L/R	3135,-	3793,-
🔑 K PZ-LI/RE	3360,-	4065,-
🔑 K PZ-LI/RE vyošená koule	3360,-	4065,-

	bez DPH	s DPH
EUR		
🔑 PZ L/R	133,4	160,1
🔑 K PZ-LI/RE	143,0	171,6
🔑 K PZ-LI/RE vyošená koule	143,0	171,6

K

Salzburg

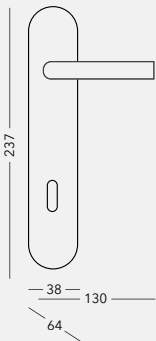

	bez DPH	s DPH
CZK		
🔑 BB/PZ	2815,-	3406,-
🔑 WC	3725,-	4507,-
🔑 PZ-LI/RE	3170,-	3836,-

	bez DPH	s DPH
EUR		
🔑 BB/PZ	119,8	143,7
🔑 WC	158,5	190,2
🔑 PZ-LI/RE	134,9	161,9

K

Salzburg-S



	bez DPH	s DPH
CZK		
🔑 BB/PZ	2800,-	3388,-
🔑 WC	3735,-	4519,-

	bez DPH	s DPH
EUR		
🔑 BB/PZ	119,1	143,0
🔑 WC	158,9	190,7

K

Venezia

rustikalní

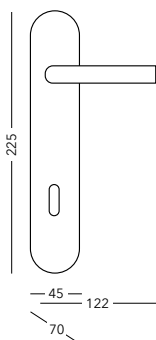

	bez DPH	s DPH
CZK		
🔑 BB/PZ	540,-	654,-
🔑 WC	655,-	793,-
🔑 PZ-LI/RE	710,-	859,-

	bez DPH	s DPH
EUR		
🔑 BB/PZ	23,0	27,6
🔑 WC	27,9	33,4
🔑 PZ-LI/RE	30,2	36,3

K OFS

Venezia-R

rustikalní

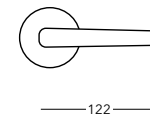

	bez DPH	s DPH
CZK		
🔑 BB/PZ	595,-	720,-
🔑 WC	705,-	853,-
🔑 PZ-LI/RE	765,-	926,-

	bez DPH	s DPH
EUR		
🔑 BB/PZ	25,3	30,4
🔑 WC	30,0	36,0
🔑 PZ-LI/RE	32,6	39,1

K

Vienna-R+



CZK bez DPH s DPH
PZ-LI/RE 4325,- 5223,-

EUR bez DPH s DPH
PZ-LI/RE 184,0 220,9

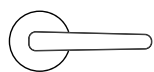

— 120 —



— 55 —

— 59 —



Koule pevná Bonn HR

CZK bez DPH s DPH
cena ks 1065,- 1289,-

EUR bez DPH s DPH
cena ks 45,3 54,4



— 52 —

— 48 —



Koule pevná Linz HR

CZK bez DPH s DPH
cena ks 975,- 1180,-

EUR bez DPH s DPH
cena ks 41,5 49,8

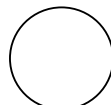

— Ø 55 —

— 45 —

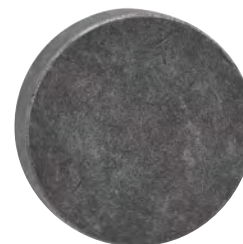

SNADNÁ DOSTUPNOST

Produkty značky COBRA jsou snadno a rychle dostupné díky pečlivě budované husté síti obchodních partnerů. Podporujeme také on-line prodej, ale jsme si vědomi, že u kliky je důležitá možnost sáhnout si na ni, nebo na vlastní oči posoudit zvolený materiál. Proto nám záleží na tom, aby COBRA byla dostupná všem zákazníkům, kdykoli a kdekoli.

RYCHLÉ DODÁNÍ

Standardně dodáváme v nejrychlejších lhůtách. Máte jistotu, že vaše plány proběhnou tak, jak si představujete. Díky naší široké distribuční síti a stále dostupnosti našich výrobků můžeme slíbit, že se kliky COBRA dostanou vždy rychle a spolehlivě až k Vám.

www.cobra-cz.cz

EASILY AVAILABLE

Cobra products are quickly and easily available owing to well-made network of business partners. We also support sales on - line despite the fact that we know it is very important having the possibility to touch the handle material and judge it with one's own eyes . Therefore our main target is for COBRA to be available to all customers - anytime and anywhere.

FAST DELIVERY

We usually deliver as fast as we can. You can be sure that your plans will take place according to your requirements. Thanks to our distribution network and availability of our products we are able to assure you that COBRA handles will easily and quickly find their way to you.

K





Bezpečnostní a ochranné kování

SECURITY FITTINGS

98	Alt-wien	99	Elegant+	101	Tower-H
98	Alt-wien+	99	Mars-S+	102	Tower-H+
98	Apollo+	100	Slim-2	102	Rozeta Tower
98	C101+	100	Sveva	102	Přídavná rozeta hranatá
98	C201	100	Sveva+	102	Přídavná rozeta kulatá
98	C301	100	Titan	102	Přídavná rozeta oválná
99	C501+	100	Titan+		
99	Diana-R+	101	Tower		
99	Elegant	101	Tower+		

Prvořadým úkolem bezpečnostních kování je ochránit váš dům či byt. U nás máte možnost vybrat kliku nejen podle potřebné bezpečnostní třídy, ale zvolit si i svůj oblíbený design a povrch tak, aby i bezpečnostní kování odpovídalo vašim představám i celkovému designu vašeho obydlí.

The main purpose of security fittings is to protect your house or flat. In our company you have a possibility to select a handle not only according to required security class, but you can also choose your favourite design and surface and security fitting in a way which would correspond with your wishes and the overall design of your dwelling.



Alt-wien



Možno v rozteči 72, 90, 92

CZK	bez DPH	s DPH
🔑 PZ L/R	2230,-	2698,-
🔑 K PZ-LI/RE	2230,-	2698,-
EUR	bez DPH	s DPH
🔑 PZ L/R	94,9	113,9
🔑 K PZ-LI/RE	94,9	113,9

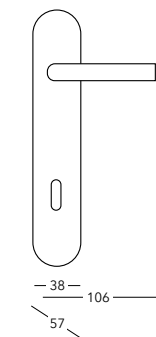

OFS OLV OV



Alt-wien+



Možno v rozteči 72, 90, 92

CZK	bez DPH	s DPH
🔑 PZ L/R	2800,-	3388,-
🔑 K PZ-LI/RE	2800,-	3388,-
EUR	bez DPH	s DPH
🔑 PZ L/R	119,1	143,0
🔑 K PZ-LI/RE	119,1	143,0

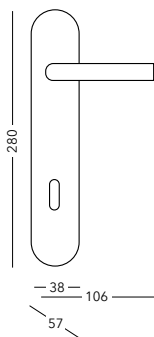

OFS OLV OV



Apollo+



Možno v rozteči 72 a 92

CZK	bez DPH	s DPH
🔑 PZ L/R	3200,-	3872,-
🔑 K PZ-LI/RE	3520,-	4260,-
EUR	bez DPH	s DPH
🔑 PZ L/R	136,2	163,4
🔑 K PZ-LI/RE	149,8	179,8

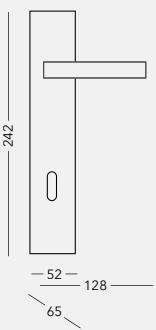

Černá



C101+



Možno v rozteči 72 a 90

CZK	bez DPH	s DPH
🔑 M PZ-LI/RE	710,-	859,-
EUR	bez DPH	s DPH
🔑 M PZ-LI/RE	30,2	36,3

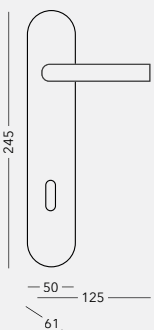

OFS ONS



C201



Možno v rozteči 72 a 90

CZK	bez DPH	s DPH
🔑 PZ-LI/RE	820,-	992,-
EUR	bez DPH	s DPH
🔑 PZ-LI/RE	34,9	41,9

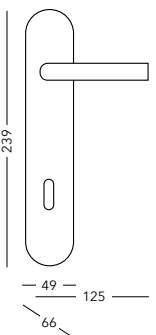

ONS OFS



C301



Možno v rozteči 72 a 90

CZK	bez DPH	s DPH
🔑 PZ-LI/RE	820,-	992,-
EUR	bez DPH	s DPH
🔑 PZ-LI/RE	34,9	41,9

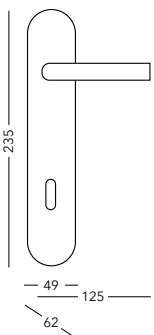

ONS OFS



C501+



Možno v rozteči 72 a 90

CZK		bez DPH	s DPH
🔑	PZ L/R	1990,-	2408,-
🔑	K PZ-LI/RE	1990,-	2408,-
EUR		bez DPH	s DPH
🔑	PZ L/R	84,7	101,6
🔑	K PZ-LI/RE	84,7	101,6

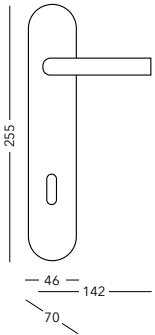

IN

Diana-R+



CZK		bez DPH	s DPH
🔑	PZ L/R	2555,-	3092,-
🔑	K PZ-LI/RE	2770,-	3352,-
EUR		bez DPH	s DPH
🔑	PZ L/R	108,7	130,5
🔑	K PZ-LI/RE	117,9	141,4

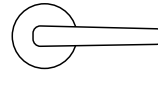

F1 F9 F4



Elegant



Možno v rozteči 72, 90, 92

CZK		bez DPH	s DPH
🔑	PZ L/R	1850,-	2239,-
🔑	K PZ-LI/RE	1850,-	2239,-
EUR		bez DPH	s DPH
🔑	PZ L/R	78,7	94,5
🔑	K PZ-LI/RE	78,7	94,5

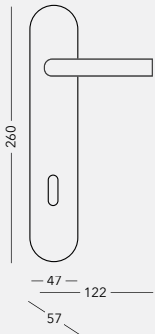

OFS OLV OV

Elegant+



Možno v rozteči 72, 90, 92

CZK		bez DPH	s DPH
🔑	PZ L/R	2630,-	3182,-
🔑	K PZ-LI/RE	2630,-	3182,-
EUR		bez DPH	s DPH
🔑	PZ L/R	111,9	134,3
🔑	K PZ-LI/RE	111,9	134,3

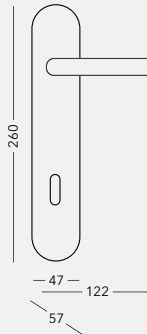

OFS OLV OV

Mars-S+



CZK		bez DPH	s DPH
🔑	PZ L/R	2555,-	3092,-
🔑	K PZ-LI/RE	2770,-	3352,-
EUR		bez DPH	s DPH
🔑	PZ L/R	108,7	130,5
🔑	K PZ-LI/RE	117,9	141,4

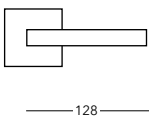

CZK		bez DPH	s DPH	EUR		bez DPH	s DPH
🔑	PZ L/R	2665,-	3225,-	🔑	PZ L/R	113,4	136,1
🔑	K PZ-LI/RE	2880,-	3485,-	🔑	K PZ-LI/RE	122,6	147,1

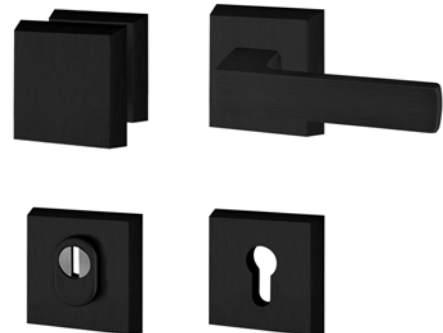

Cerná

F1

Slim-2



Možno v rozteči 72, 90, 92

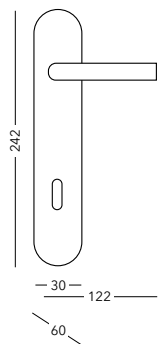

F1 F4



CZK	bez DPH	s DPH
🔑 PZ L/R	540,-	654,-
🔑 K PZ-LI/RE	590,-	714,-
EUR	bez DPH	s DPH
🔑 PZ L/R	23,0	27,6
🔑 PZ-LI/RE	25,1	30,1

Slim-2



Možno v rozteči 72, 90, 92

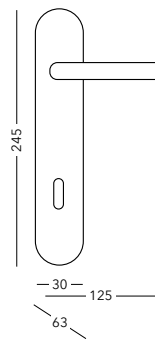

F9



CZK	bez DPH	s DPH
🔑 PZ L/R	590,-	714,-
🔑 PZ-LI/RE	620,-	750,-
EUR	bez DPH	s DPH
🔑 PZ L/R	25,1	30,1
🔑 PZ-LI/RE	26,4	31,7

Sveva



Možno v rozteči 72, 90, 92

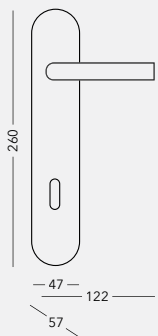

OC ONS OFS OLV



CZK	bez DPH	s DPH
🔑 PZ L/R	1340,-	1621,-
🔑 K PZ-LI/RE	1340,-	1621,-
EUR	bez DPH	s DPH
🔑 PZ L/R	57,0	68,4
🔑 PZ-LI/RE	57,0	68,4

Sveva+



Možno v rozteči 72, 90, 92

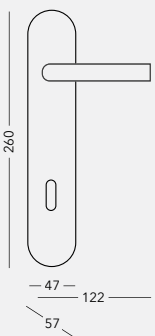

OC ONS OFS OLV



CZK	bez DPH	s DPH
🔑 PZ L/R	2125,-	2571,-
🔑 K PZ-LI/RE	2125,-	2571,-
EUR	bez DPH	s DPH
🔑 PZ L/R	90,4	108,5
🔑 PZ-LI/RE	90,4	108,5

Titan



Možno v rozteči 72, 90, 92

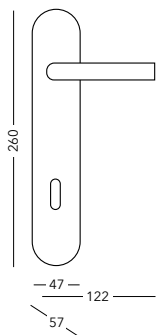

OC ONS OFS OLV



CZK	bez DPH	s DPH
🔑 PZ L/R	1340,-	1621,-
🔑 K PZ-LI/RE	1340,-	1621,-
EUR	bez DPH	s DPH
🔑 PZ L/R	57,0	68,4
🔑 PZ-LI/RE	57,0	68,4

Titan+



Možno v rozteči 72, 90, 92

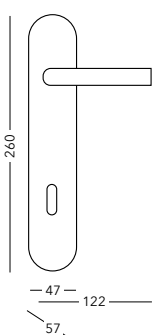

OC ONS OFS OLV



CZK	bez DPH	s DPH
🔑 PZ L/R	2125,-	2571,-
🔑 K PZ-LI/RE	2125,-	2571,-
EUR	bez DPH	s DPH
🔑 PZ L/R	90,4	108,5
🔑 PZ-LI/RE	90,4	108,5

Tower



Možno v rozteči 72, 90, 92

CZK	bez DPH	s DPH
🔑 PZ L/R	950,-	1150,-
🔑 K PZ-LI/RE	950,-	1150,-
EUR	bez DPH	s DPH
🔑 PZ L/R	40,4	48,5
🔑 K PZ-LI/RE	40,4	48,5

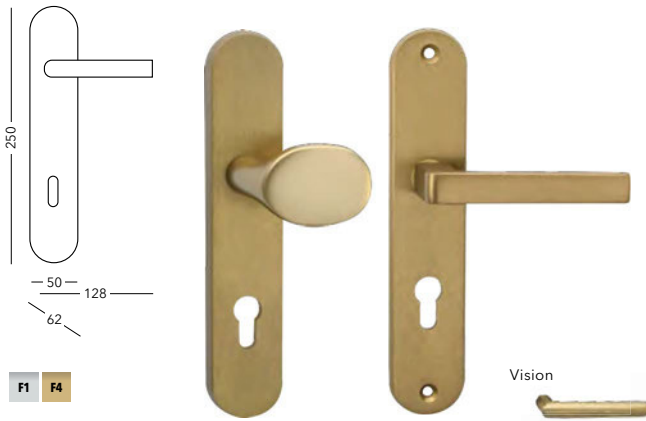

Tower



Možno v rozteči 72, 90, 92

CZK	bez DPH	s DPH
🔑 PZ L/R	1100,-	1331,-
🔑 K PZ-LI/RE	1100,-	1331,-
EUR	bez DPH	s DPH
🔑 PZ L/R	44,7	53,6
🔑 K PZ-LI/RE	44,7	53,6

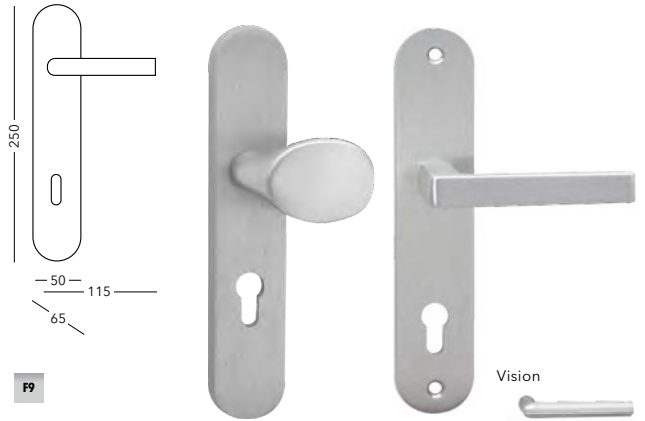

Tower+



Možno v rozteči 72, 90, 92

CZK	bez DPH	s DPH
🔑 PZ L/R	1340,-	1621,-
🔑 K PZ-LI/RE	1340,-	1621,-
EUR	bez DPH	s DPH
🔑 PZ L/R	57,0	68,4
🔑 K PZ-LI/RE	57,0	68,4



Tower+



Možno v rozteči 72, 90, 92

CZK	bez DPH	s DPH
🔑 PZ L/R	1440,-	1742,-
🔑 K PZ-LI/RE	1440,-	1742,-
EUR	bez DPH	s DPH
🔑 PZ L/R	61,3	73,5
🔑 K PZ-LI/RE	61,3	73,5

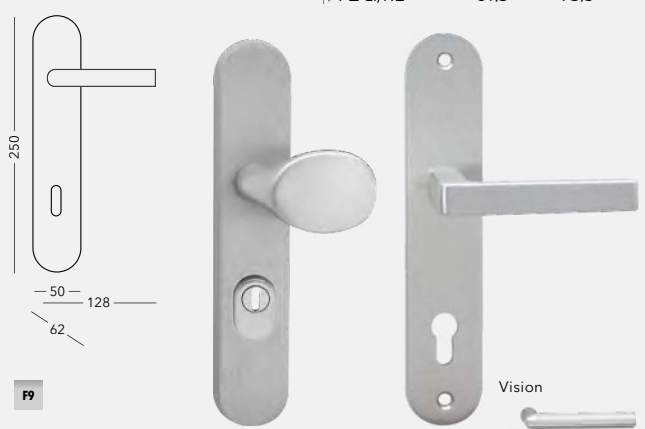

Tower-H



Možno v rozteči 72, 90, 92

CZK	bez DPH	s DPH
🔑 PZ L/R	1000,-	1211,-
🔑 K PZ-LI/RE	1000,-	1211,-
EUR	bez DPH	s DPH
🔑 PZ L/R	42,6	51,1
🔑 K PZ-LI/RE	42,6	51,1



Tower-H



Možno v rozteči 72, 90, 92

CZK	bez DPH	s DPH
🔑 PZ L/R	1050,-	1271,-
🔑 K PZ-LI/RE	1050,-	1271,-
EUR	bez DPH	s DPH
🔑 PZ L/R	44,7	53,6
🔑 K PZ-LI/RE	44,7	53,6



Tower-H+



Možno v rozteči 72, 90, 92

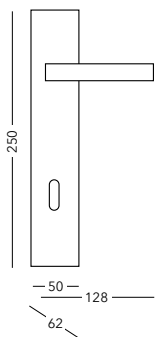

F1 F4



CZK		bez DPH	s DPH
🔑	PZ L/R	1340,-	1621,-
🔑	K PZ-LI/RE	1340,-	1621,-
EUR		bez DPH	s DPH
🔑	PZ L/R	57,0	68,4
🔑	PZ-LI/RE	57,0	68,4



Možno v rozteči 72, 90, 92

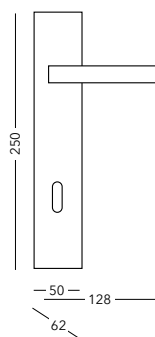

F9



CZK		bez DPH	s DPH
🔑	PZ L/R	1440,-	1742,-
🔑	K PZ-LI/RE	1440,-	1742,-
EUR		bez DPH	s DPH
🔑	PZ L/R	61,3	73,5
🔑	PZ-LI/RE	61,3	73,5

Rozeta Tower

cena za pár

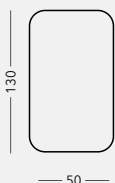

F1 F9 F4



CZK		bez DPH	s DPH
🔑	PZ	740,-	895,-
EUR		bez DPH	s DPH
🔑	PZ	31,5	37,8

Přídavná rozeta hranatá

cena za pár

Povrch	obj.číslo	CZK	s DPH	EUR	s DPH
IN	ALMBROZHE 349	🔑 PZ 1485,-	1797,-	63,2	75,8
OLV	ALMBROZHE 379	🔑 PZ 11485,-	1797,-	63,2	75,8

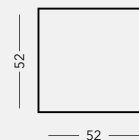

IN OLV



Přídavná rozeta kulatá

cena za pár

Povrch	obj.číslo	CZK	s DPH	EUR	s DPH
IN	ALMBROZKE 369	🔑 PZ 1380,-	1670,-	58,7	70,5
OLV	ALMBROZKE 399	🔑 PZ 1380,-	1670,-	58,7	70,5

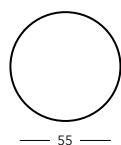

IN OLV



Přídavná rozeta oválná

cena za pár

Povrch	obj.číslo	CZK	s DPH	EUR	s DPH
IN	ALMBROZOE 359	🔑 PZ 1165,-	1410,-	49,6	59,5
OLV	ALMBROZOE 389	🔑 PZ 1165,-	1410,-	49,6	59,5



IN OLV



BK



S

Sety

SETS

Set Alt-wien

- 106 Alt-wien
- 106 Alt-wien ochranné
- 106 Okenní kování
- 106 Oliva
- 106 Půloliva
- 106 Půloliva velká
- 106 Úchytka 3665 bez otvoru
- 106 Úchytka 3665 BB
- 106 Úchytka 3665 WC

Set Vision

- 107 Vision-R III
- 107 R-701+
- 107 Oliva Vision
- 107 Půloliva Vision
- 107 Balkónová klika Vision
- 107 Úchytka hranatá bez otvoru
- 107 Úchyt 3665 narážecí
- 107 Úchyt na posuvné dveře D

Set hliník

- 108 Universal
- 108 Tower-H
- 108 Universal-R
- 108 Tower
- 108 Oliva
- 108 Půloliva
- 108 Balkónová klika ST3

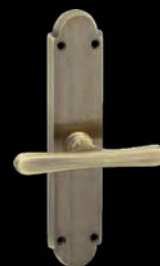



Chcete sladit design dveřních a okenních kování s okny? Připravili jsme pro vás kompletní sety, které vám umožní vybavit dveře i okna kováními a úchyty v totožném povrchu i tvaru a dosáhnout tak celkového sjednocení zásadních designových prvků vaší domácnosti.

Do you wish to match the design of your doors and windows fittings? We have prepared a complete sets which will enable you to fit the doors as well as windows with fittings and mountings in an identical surface and shape thus reaching the overall integration of essential design elements of your household.

Set Alt-wien

Alt-wien

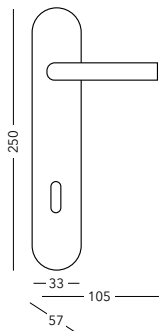

	bez DPH	s DPH
CZK		
BB/PZ	660,-	799,-
WC	810,-	980,-
PZ-LI/RE	885,-	1071,-
EUR		
BB/PZ	28,1	33,7
WC	34,5	41,4
PZ-LI/RE	37,7	45,2

Alt-wien

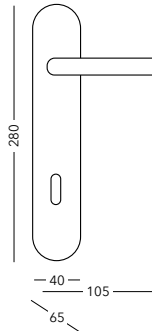

	bez DPH	s DPH
CZK		
PZ L/R	2230,-	2698,-
K PZ-LI/RE	2230,-	2698,-
EUR		
PZ L/R	94,9	113,9
K PZ-LI/RE	94,9	113,9

Okenní kování Alt-Wien



Oliva			Půlolina			Půlolina velká			Balkonová klika			Rozvora		
obj. číslo	P06458X60B		obj. číslo	P06448X00B		obj. číslo	P06468X00N		obj. číslo	P06478X00B		obj. číslo	P06438X00B	
CZK	bez DPH	s DPH	CZK	bez DPH	s DPH	CZK	bez DPH	s DPH	CZK	bez DPH	s DPH	CZK	bez DPH	s DPH
cena	335,-	405,-	cena	305,-	369,-	cena	355,-	430,-	cena	440,-	532,-	cena	415,-	502,-
EUR	bez DPH	s DPH	EUR	bez DPH	s DPH	EUR	bez DPH	s DPH	EUR	bez DPH	s DPH	EUR	bez DPH	s DPH
PZ L/R	14,3	17,1	PZ L/R	13,0	15,6	PZ L/R	15,1	18,1	PZ L/R	18,7	22,5	PZ L/R	17,7	21,2

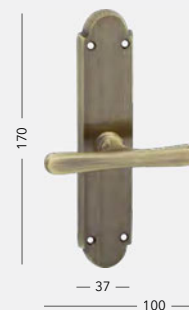
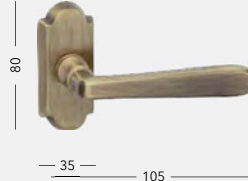
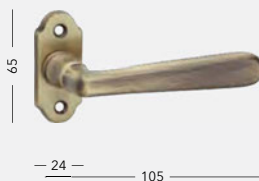
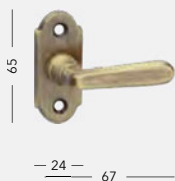
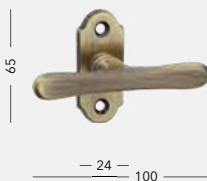

Úchytky 3665



bez otvoru

obj. číslo	P17908PRX03PAR	
CZK	bez DPH	s DPH
cena za pár	385,-	466,-
EUR	bez DPH	s DPH
cena za pár	16,4	19,7

BB

obj. číslo	P17908X13PAR	
CZK	bez DPH	s DPH
cena za pár	395,-	478,-
EUR	bez DPH	s DPH
cena za pár	16,8	20,2

WC

obj. číslo	P17908X3312PAR	
CZK	bez DPH	s DPH
cena za pár	630,-	762,-
EUR	bez DPH	s DPH
cena za pár	26,8	32,2



Set Vision

Vision-R III



	bez DPH	s DPH
CZK		
BB/PZ	270.-	327.-
WC	440.-	532.-
PZ-LI/RE	500.-	605.-
EUR	bez DPH	s DPH
BB/PZ	11,5	13,8
WC	18,7	22,5
PZ-LI/RE	21,3	25,5

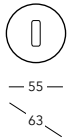
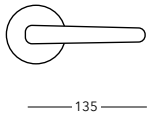

IN

C501+



Možno v rozteči 72 a 90

	bez DPH	s DPH
CZK		
PZ L/R	1990.-	2408.-
PZ-LI/RE	1990.-	2408.-
EUR	bez DPH	s DPH
PZ L/R	84,7	101,6
PZ-LI/RE	84,7	101,6

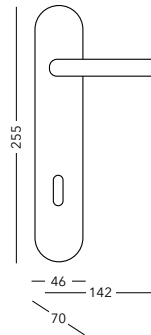

IN



Okenní kování Vision

IN

Oliva Vison

	bez DPH	s DPH
CZK		
cena	285.-	345.-
EUR	bez DPH	s DPH
PZ L/R	12,1	14,6

Půlolliva Vision

	bez DPH	s DPH
CZK		
cena	260.-	315.-
EUR	bez DPH	s DPH
PZ L/R	11,1	13,3

Balk. Vision

	bez DPH	s DPH
CZK		
cena	285.-	345.-
EUR	bez DPH	s DPH
PZ L/R	12,1	14,6

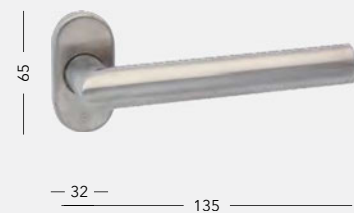
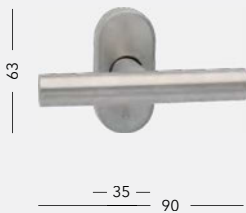

Úchytky Nerezové

IN

Hranatá bez otvoru

obj. číslo	C1592EX03	
CZK	bez DPH	s DPH
cena za kus	205.-	248.-
EUR	bez DPH	s DPH
cena za kus	8,7	10,5

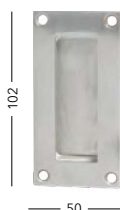

Úchyt 3665 narážecí

obj. číslo	P1790EX03PAR	
CZK	bez DPH	s DPH
cena za pár	385.-	466.-
EUR	bez DPH	s DPH
cena za pár	16,4	19,7



Úchyt pos. dveře D

obj. číslo	C160EXD	
CZK	bez DPH	s DPH
cena za kus	326.-	395.-
EUR	bez DPH	s DPH
cena za kus	13,9	16,7

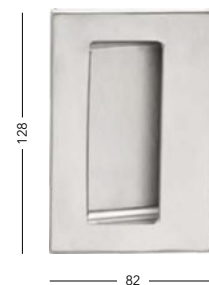

Set Hliník

Universal

OK 100 tis.

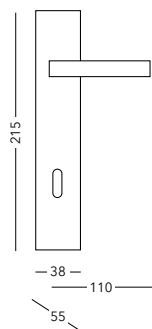

F1 F4

	bez DPH	s DPH
CZK		
BB/PZ	215,-	260,-
WC	275,-	333,-
PZ-LI/RE	325,-	393,-

	bez DPH	s DPH
EUR		
BB/PZ	9,1	11,0
WC	11,7	14,0
PZ-LI/RE	13,8	16,6



Tower H

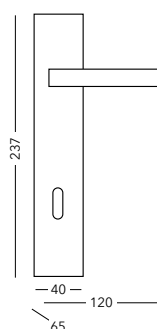

F1 F4

	bez DPH	s DPH
CZK		
BB/PZ	1000,-	1211,-
PZ-LI/RE	1000,-	1211,-

	bez DPH	s DPH
EUR		
BB/PZ	42,6	51,1
PZ-LI/RE	42,6	51,1



Universal-R

OK 100 tis.

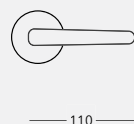

F1 F4

	bez DPH	s DPH
CZK		
BB/PZ	215,-	260,-
WC	275,-	333,-
PZ-LI/RE	325,-	393,-

	bez DPH	s DPH
EUR		
BB/PZ	9,1	11,0
WC	11,7	14,0
PZ-LI/RE	13,8	16,6



Tower

OK

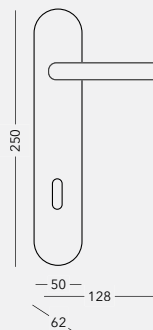

F1 F4

	bez DPH	s DPH
CZK		
PZ L/R	950,-	1150,-
K PZ-LI/RE	950,-	1150,-

	bez DPH	s DPH
EUR		
PZ L/R	40,4	48,5
PZ-LI/RE	40,4	48,5



Okenní kování

F1 F4

Oliva

	bez DPH	s DPH
CZK		
cena	105,-	127,-
EUR		
PZ L/R	4,5	5,4

Půlolliva

	bez DPH	s DPH
CZK		
cena	110,-	133,-
EUR		
PZ L/R	4,7	5,6

Balkonová klika ST3

	bez DPH	s DPH
CZK		
cena	145,-	175,-
EUR		
PZ L/R	6,2	7,4

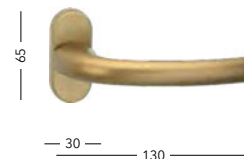
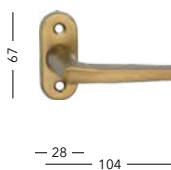
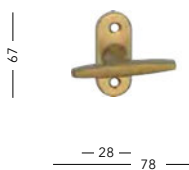





Stříbrný elox

SILVER ELOX

- 112 Monet
- 112 Monet-R
- 112 Universal
- 112 Universal-R





Jednou z významných předností našich nabízených klik ze stříbrného eloxu je jejich odolný povrch. Díky povrchové úpravě jsou odolnější vůči poškrábání a snesou tvrdší zacházení. Barevný odstín stříbrného eloxu předurčuje kliky do světlých interiérů.

One of the advantages of our handles made of silver elox is their durable surface. Thanks to surface treatment they are more durable against scratching and they can also endure harsher treatment. Coloured shade of silver elox makes the handles a great choice especially in light interiors.

Monet

100 tis.

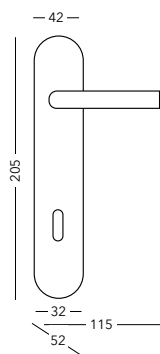

CZK		bez DPH	s DPH
🔑	BB/PZ	215,-	260,-
	WC	280,-	339,-
🔑	PZ-LI/RE	325,-	393,-
EUR		bez DPH	s DPH
🔑	BB/PZ	9,1	11,0
	WC	11,9	14,3
🔑	PZ-LI/RE	13,8	16,6



F1 F4

Monet-R

100 tis. PR

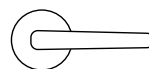

F1 F4

Universal

100 tis.

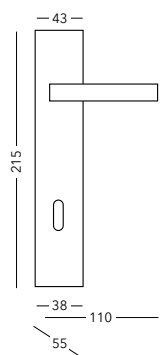

CZK		bez DPH	s DPH
🔑	BB/PZ	215,-	260,-
	WC	275,-	333,-
🔑	PZ-LI/RE	325,-	393,-
EUR		bez DPH	s DPH
🔑	BB/PZ	9,1	11,0
	WC	11,7	14,0
🔑	PZ-LI/RE	13,8	16,6



F1 F4

Universal-R

100 tis. PR



F1 F4

SNADNÁ DOSTUPNOST

produkty COBRA jsou snadno a rychle dostupné díky pečlivě budované síti obchodních partnerů. Podporujeme také on-line prodej, ale víme, že u kliky je důležitá možnost sáhnout si na ni a na vlastní oči posoudit zvolný materiál. Proto nám záleží na tom, aby COBRA byla dostupná všem zákazníkům - kdykoliv a kdekoli.

RYCHLÉ DODÁNÍ

Standardně dodáváme v nejrychlejších lhůtách. Máte jistotu, že vaše plány proběhnou tak, jak si představujete. Díky naší distribuční síti a dostupnosti našich výrobků můžeme slíbit, že se kliky COBRA dostanou vždy rychle a spolehlivě až k vám.



COBRA[®] 

EASILY AVAILABLE

Cobra products are quickly and easily available owing to well-made network of business partners. We also support sales on - line despite the fact that we know it is very important having the possibility to touch the handle material and judge it with one's own eyes . Therefore our main target is for COBRA to be available to all customers - anytime and anywhere.

FAST DELIVERY

We usually deliver as fast as we can. You can be sure that your plans will take place according to your requirements. Thanks to our distribution network and availability of our products we are able to assure you that COBRA handles will easily and quickly find their way to you.



F4

Bronzový elox

BRASS ELOX

116 Monet
116 Monet-R
116 Universal
116 Universal-R

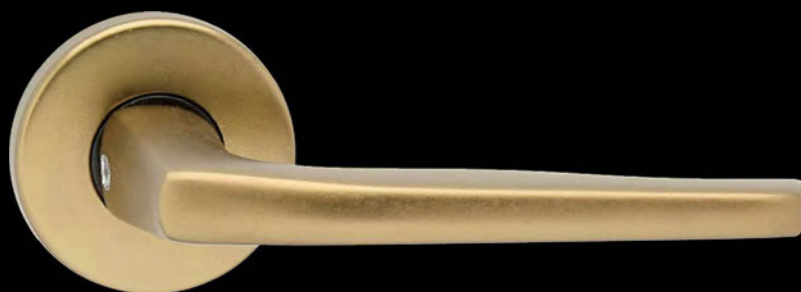



Významnou předností kování z bronzového eloxu je jejich odolný povrch. Povrchová úprava zajišťuje větší tvrdost a odolnost vůči poškrábání.

Significant advantage of brass elox fittings is their resistant surface. Surface treatment ensures bigger hardness and durability against scratching.

Monet

100 tis.

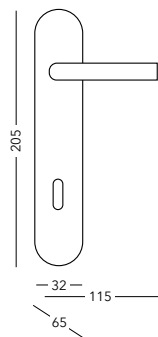

	bez DPH	s DPH
CZK		
🔑 BB/PZ	215.-	260.-
🔑 WC	275.-	333.-
🔑 PZ-LI/RE	325.-	393.-
EUR		
🔑 BB/PZ	9,1	11,0
🔑 WC	11,7	14,0
🔑 PZ-LI/RE	13,8	16,6



F1 F4

Monet-R

100 tis. PR



	bez DPH	s DPH
CZK		
🔑 BB/PZ	215.-	260.-
🔑 WC	275.-	333.-
EUR		
🔑 BB/PZ	9,1	11,0
🔑 WC	11,7	14,0



F1 F4

Universal

100 tis.

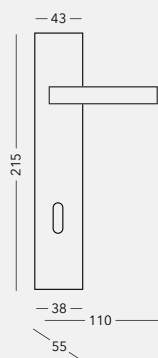

	bez DPH	s DPH
CZK		
🔑 BB/PZ	215.-	260.-
🔑 WC	275.-	333.-
🔑 PZ-LI/RE	325.-	393.-
EUR		
🔑 BB/PZ	9,1	11,0
🔑 WC	11,7	14,0
🔑 PZ-LI/RE	13,8	16,6



F1 F4

Universal-R

100 tis. PR

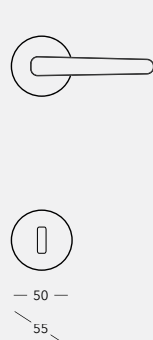

	bez DPH	s DPH
CZK		
🔑 BB/PZ	215.-	260.-
🔑 WC	275.-	333.-
🔑 PZ-LI/RE	325.-	393.-
EUR		
🔑 BB/PZ	9,1	11,0
🔑 WC	11,7	14,0
🔑 PZ-LI/RE	13,8	16,6



F1 F4

ODBORNÉ PORADENSTVÍ ZDARMA

Vybírejte bez starostí. S čímkoliv bude třeba, rádi poradíme. Pravidelným školení a vzděláváním naší obchodní sítě zajišťujeme, aby vám odborníci vždy dokázali správně poradit nebo doporučit nevhodnější kliku.

POPRODEJNÍ SERVIS

COBRA ručí za spolehlivé fungování. Prodejem naše péče o zákazníky nekončí. Pečlivě a systematicky rozvíjíme a podporujeme síť našich partnerů, kteří jsou díky tomu vždy připraveni poskytnout vám poprodejní služby spojené s údržbou našich výrobků nebo s dodávkou náhradních dílů.

FREE OF CHARGE CONSULTANCY

Be worry-free while you choose. Whatever the issue, we will be glad to help you. Thanks to regular training programmes and continuous education of our commercial network we can ensure that our professionals are always able to assist you or to recommend you the most appropriate handle..

AFTER SALES SERVICE

COBRA guarantees reliable functioning. Selling our product does not mean the end of our customer care. We carefully and systematically develop and support network of our business partners who are thus ready to provide you with after sales services related to our products' maintenance as well as with the delivery of spare parts.

F4



OKENNÍ KOVÁNÍ

Okenní kování

WINDOW FITTINGS

120	Alt-wien	122	F1	123	kované
121	Elegant	122	F4	123	Vision





Okenní kování Alt-Wien

staromosaz

Oliva

CZK	s DPH
365,-	442,-
EUR	s DPH
15,5	18,6

Půloliva

CZK	s DPH
325,-	393,-
EUR	s DPH
13,8	16,6

Půloliva velká

CZK	s DPH
375,-	453,-
EUR	s DPH
15,9	19,1

Balkonová klika

CZK	s DPH
465,-	563,-
EUR	s DPH
19,8	23,8

Rozvora

CZK	s DPH
440,-	532,-
EUR	s DPH
18,7	22,5

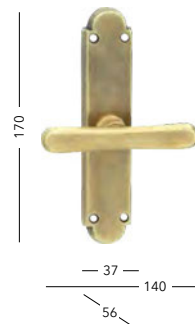
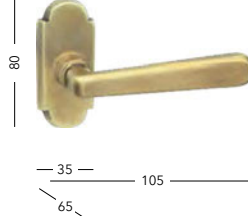
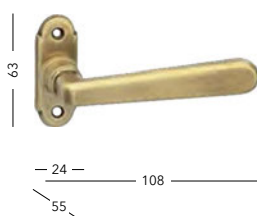
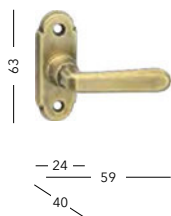
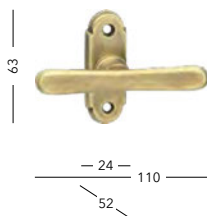

OV Lze dodat i s metrickými šrouby M5x16

Okenní kování Alt-Wien

nikl matný, leštěná mosaz, česaný bronz, chrom, chrom matný

Oliva

CZK	s DPH
335,-	405,-
EUR	s DPH
14,3	17,1

Půloliva

CZK	s DPH
305,-	369,-
EUR	s DPH
13,0	15,6

Půloliva velká

CZK	s DPH
355,-	430,-
EUR	s DPH
15,1	18,1

Balkonová klika

CZK	s DPH
440,-	532,-
EUR	s DPH
18,7	22,5

Rozvora

CZK	s DPH
415,-	502,-
EUR	s DPH
17,7	21,2

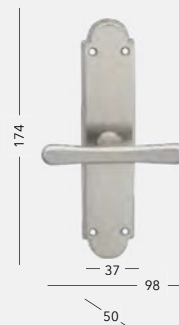
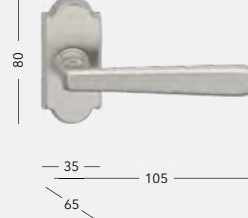
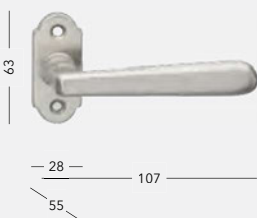
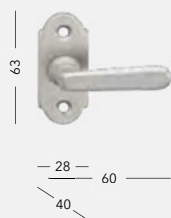
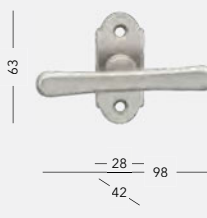

ONS **OFS** **OLV** **OC** **OCS** Lze dodat i s metrickými šrouby M5x16

Okenní kování Elegant

staromosaz

Oliva

CZK	₰ DPH
305,-	369,-
EUR	₰ DPH
13,0	15,6

Půlolina

CZK	₰ DPH
285,-	345,-
EUR	₰ DPH
12,1	14,6

Půlolina velká

CZK	₰ DPH
350,-	424,-
EUR	₰ DPH
14,9	17,9

Balkonová klika

CZK	₰ DPH
400,-	484,-
EUR	₰ DPH
17,0	20,4

Rozvora

CZK	₰ DPH
375,-	453,-
EUR	₰ DPH
15,9	19,1

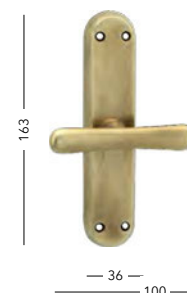
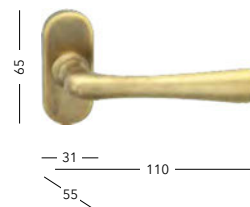
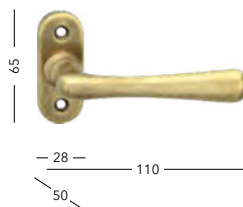
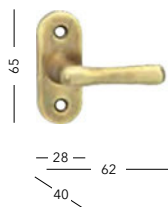
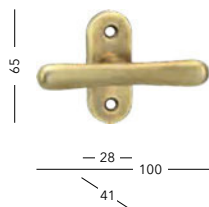

ov Lze dodat i s metrickými šrouby M5x16

Okenní kování Elegant

nikl matný, leštěná mosaz, česaný bronz

Oliva

CZK	₰ DPH
285,-	345,-
EUR	₰ DPH
12,1	14,6

Půlolina

CZK	₰ DPH
260,-	315,-
EUR	₰ DPH
11,1	13,3

Půlolina velká

CZK	₰ DPH
325,-	393,-
EUR	₰ DPH
13,8	16,6

Balkonová klika

CZK	₰ DPH
330,-	399,-
EUR	₰ DPH
14,0	16,9

Rozvora

CZK	₰ DPH
355,-	430,-
EUR	₰ DPH
15,1	18,1

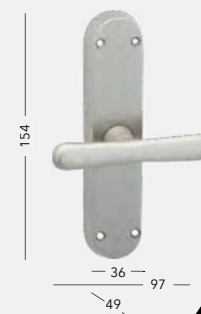
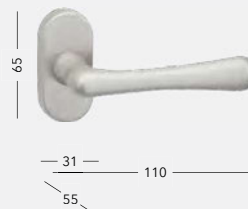
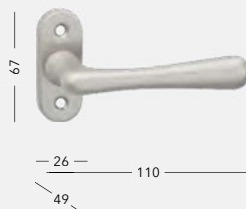
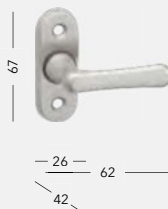
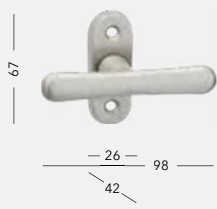

ONS OFS OLV OC OCS Lze dodat i s metrickými šrouby M5x16

Okenní kování F1

stříbrný elox

Oliva

CZK	s DPH
105,-	127,-
EUR	s DPH
4,5	5,4

Půlolina

CZK	s DPH
110,-	133,-
EUR	s DPH
4,7	5,6

Balkonová klika

CZK	s DPH
145,-	175,-
EUR	s DPH
6,2	7,4

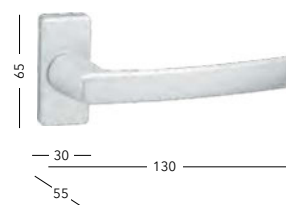
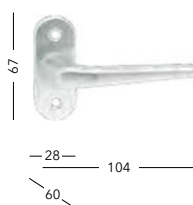
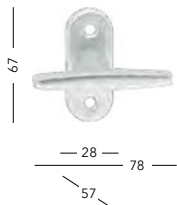

F1

Okenní kování F4

bronzový elox

Oliva

CZK	s DPH
105,-	127,-
EUR	s DPH
4,5	5,4

Půlolina

CZK	s DPH
110,-	133,-
EUR	s DPH
4,7	5,6

Balkonová klika

CZK	s DPH
145,-	175,-
EUR	s DPH
6,2	7,4

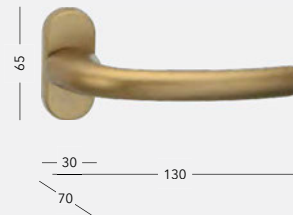
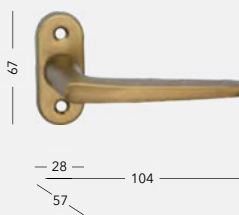
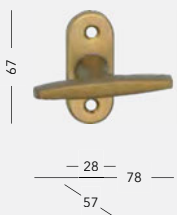

F4

Okenní kování kované

Oliva Hamburg

CZK	s DPH
1000,-	1211,-
EUR	s DPH
42,6	51,1

Půlolina velká Hamburg

CZK	s DPH
1115,-	1349,-
EUR	s DPH
47,4	56,9

Oliva Manheim

CZK	s DPH
1000,-	1211,-
EUR	s DPH
42,6	51,1

Půlolina velká Manheim

CZK	s DPH
1115,-	1349,-
EUR	s DPH
47,4	56,9

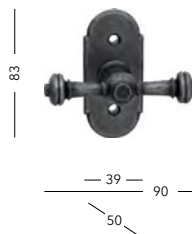
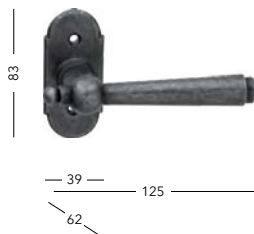
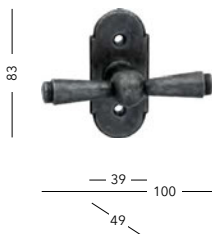

K

Okenní kování Vision

nerez

5

Oliva

CZK	s DPH
285,-	345,-
EUR	s DPH
12,1	14,6

Půlolina

CZK	s DPH
260,-	315,-
EUR	s DPH
11,1	13,3

Balkónová klíka

CZK	s DPH
285,-	345,-
EUR	s DPH
12,1	14,6

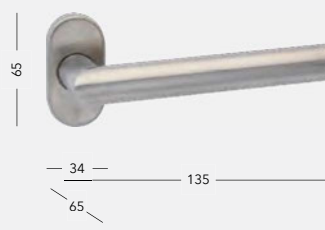
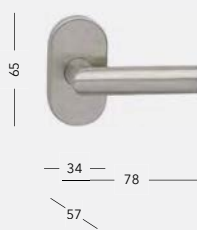
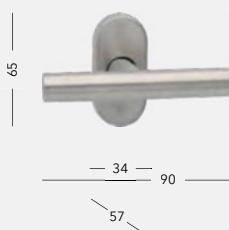

IN

MADLA ÚCHYTY

Madla / úchyty

PULL HANDLES / SLIDING DOOR PLATES

126	Madla Inox	131	Náprstky MQ	132	Úchyty
126	Madla	131	Náprstky MT	133	Úchytky
128	Madlo Bregenz	131	Náprstek Essen	133	Úchytky kované 001
128	Madlo Stein	131	Úchyt 3663	133	Úchytky kované 003
129	Madla na míru jednostranná	131	Úchyt 3665	133	Úchytky kované 004
130	Madla na míru oboustranná	132	Úchyt 3666 Kulatá	133	Úchytky Ulmen
130	Posuvný systém	132	Úchyt 3667 Hranatá	133	Úchytky Nurnberg

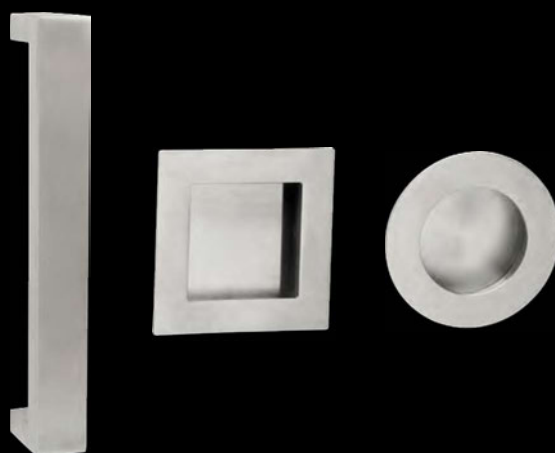



Madla INOX

Povrch	typ provedení	obj. číslo kus	CZK	s DPH	EUR	s DPH	obj. číslo pár	CZK	s DPH	EUR	s DPH
IN	INOX A	CHMADLOA	845	1023	36,0	43,2	CHMADLOAP	1060,-	1283,-	45,1	54,1
IN	INOX B	CHMADLOB	925	1119	39,4	47,2	CHMADLOBP	1275,-	1543,-	54,3	65,1
IN	INOX C	CHMADLOC	810	980	34,5	41,4	CHMADLOCP	950,-	1150,-	40,4	48,5
IN	INOX D	CHMADLOD	950	1150	40,4	48,5	CHMADLODP	1275,-	1543,-	54,3	65,1
IN	INOX E	CHMADLOE	950	1150	40,4	48,5	CHMADLOEP	1060,-	1283,-	45,1	54,1
IN	INOX F	CHMADLOF	950	1150	40,4	48,5	CHMADLOFP	1060,-	1283,-	45,1	54,1
IN	INOX G 600	CHMADLOG	845	1023	36,0	43,2	CHMADLOGP	1060,-	1283,-	45,1	54,1
IN	INOX G 700	CHMADLOH	950	1150	40,4	48,5	CHMADLOHP	1165,-	1410,-	49,6	59,5
IN	INOX G 800	CHMADLOI	1060	1283	45,1	54,1	CHMADLOIP	1275,-	1543,-	54,3	65,1
IN	INOX G 900	CHMADLOK	1165	1410	49,6	59,5	CHMADLOKP	1380,-	1670,-	58,7	70,5
IN	INOX G 1000	CHMADLOJ	1275	1543	54,3	65,1	CHMADLOJP	1485,-	1797,-	63,2	75,8
IN	INOX G 1100	CHMADLOL	1290	1561	54,9	65,8	CHMADLOLP	1490,-	1803,-	63,4	76,0

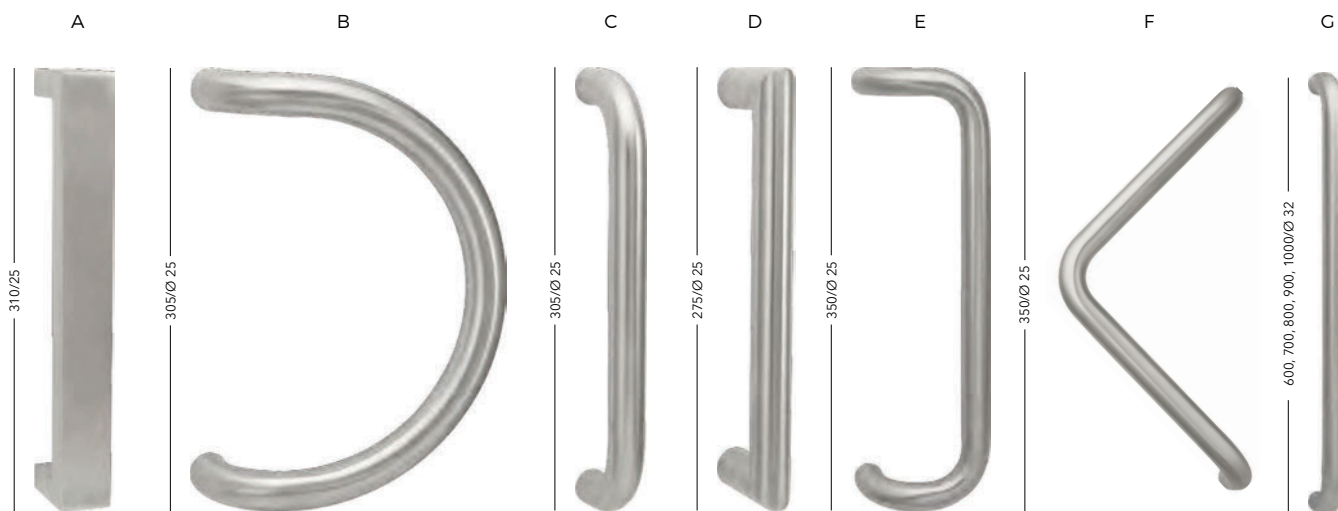

Madla

Madlo 643 nerez

Povrch	typ provedení	obj. číslo kus	CZK	s DPH	EUR	s DPH
IN	celková délka	400 CVX0643EMA0400	1820,-	2202,-	77,4	92,9
IN	celková délka	500 CVX0643EMA0500	1980,-	2395,-	84,2	101,1
IN	celková délka	600 CVX0643EMA0600	2245,-	2716,-	95,5	114,6
IN	celková délka	800 CVX0643EMA0800	2410,-	2916,-	102,6	123,1
IN	celková délka	1000 CVX0643EMA1000	2675,-	3237,-	113,8	136,6
IN	celková délka	1200 CVX0643EMA1200	2890,-	3497,-	123,0	147,6
IN	celková délka	1500 CVX0643EMA1500	3050,-	3690,-	129,8	155,7
IN	celková délka	1600 CVX0643EMA1600	3265,-	3951,-	138,9	166,7
IN	celková délka	1800 CVX0643EMA1800	3425,-	4144,-	145,7	174,9
IN	celková délka	2000 CVX0643EMA2000	3690,-	4465,-	157,0	188,4



Madla



Madlo 919 matná černá

Povrch	typ provedení	obj. číslo kus	CZK	s DPH	EUR	s DPH
Č.ANT	celková délka	400 CVX0919BMA0400	4065,-	4919,-	173,0	207,6
Č.ANT	celková délka	500 CVX0919BMA0500	4600,-	5566,-	195,7	234,9
Č.ANT	celková délka	600 CVX0919BMA0600	4975,-	6020,-	211,7	254,0
Č.ANT	celková délka	800 CVX0919BMA0800	5135,-	6213,-	218,5	262,2
Č.ANT	celková délka	1000 CVX0919BMA1000	6955,-	8416,-	296,0	355,1
Č.ANT	celková délka	1200 CVX0919BMA1200	7340,-	8882,-	312,3	374,8

Madlo 919 nerez

Povrch	typ provedení	obj. číslo kus	CZK	s DPH	EUR	s DPH
IN	celková délka	400 CVX0919EMA0400	3745,-	4531,-	159,4	191,2
IN	celková délka	500 CVX0919EMA0500	4065,-	4919,-	173,0	207,6
IN	celková délka	600 CVX0919EMA0600	4225,-	5112,-	179,8	215,7
IN	celková délka	800 CVX0919EMA0800	4600,-	5566,-	195,7	234,9
IN	celková délka	1000 CVX0919EMA1000	6315,-	7641,-	268,7	322,5
IN	celková délka	1200 CVX0919EMA1200	6740,-	8155,-	286,8	344,2



Madlo 1031 matná černá

Povrch	typ provedení	obj. číslo kus	CZK	s DPH	EUR	s DPH
Č.ANT	celková délka	400 CVX1031BMA0400	2410,-	2916,-	102,6	123,1
Č.ANT	celková délka	500 CVX1031BMA0500	2620,-	3170,-	111,5	133,8
Č.ANT	celková délka	600 CVX1031BMA0600	2780,-	3364,-	118,3	142,0
Č.ANT	celková délka	800 CVX1031BMA0800	3315,-	4011,-	141,1	169,3
Č.ANT	celková délka	1000 CVX1031BMA1000	3745,-	4531,-	159,4	191,2
Č.ANT	celková délka	1200 CVX1031BMA1200	4175,-	5052,-	177,7	213,2
Č.ANT	celková délka	1400 CVX1031BMA1500	4600,-	5566,-	195,7	234,9
Č.ANT	celková délka	1600 CVX1031BMA1600	5030,-	6086,-	214,0	256,9
Č.ANT	celková délka	1800 CVX1031BMA1800	5565,-	6734,-	236,8	284,2
Č.ANT	celková délka	2000 CVX1031BMA2000	5885,-	7121,-	250,4	300,5

Madlo 1031 nikel matný

Povrch	typ provedení	obj. číslo kus	CZK	s DPH	EUR	s DPH
ONS	celková délka	400 CVX10316MA0400	2245,-	2716,-	95,5	114,6
ONS	celková délka	500 CVX10316MA0500	2410,-	2916,-	102,6	123,1
ONS	celková délka	600 CVX10316MA0600	2535,-	3067,-	107,9	129,4
ONS	celková délka	800 CVX10316MA0800	2780,-	3364,-	118,3	142,0
ONS	celková délka	1000 CVX10316MA1000	3425,-	4144,-	145,7	174,9
ONS	celková délka	1200 CVX10316MA1200	3745,-	4531,-	159,4	191,2
ONS	celková délka	1400 CVX10316MA1500	4175,-	5052,-	177,7	213,2
ONS	celková délka	1600 CVX10316MA1600	4600,-	5566,-	195,7	234,9
ONS	celková délka	1800 CVX10316MA1800	5030,-	6086,-	214,0	256,9
ONS	celková délka	2000 CVX10316MA2000	5405,-	6540,-	230,0	276,0

Madla



Madlo 473

Povrch	typ provedení	obj. číslo kus	CZK	s DPH	EUR	s DPH
ONS	nikl matný	CVX04736MA	1155,-	1398,-	49,1	59,0
OS	mosaz matná	CVX04733MA	1155,-	1398,-	49,1	59,0
MOSA	mosaz antik	CVX0473AMA	1290,-	1561,-	54,9	65,9

Madlo 627

Povrch	typ provedení	obj. číslo kus	CZK	s DPH	EUR	s DPH
ONS	nikl matný	CVX06276MA	1155,-	1398,-	49,1	59,0
OS	mosaz matná	CVX06273MA	1155,-	1398,-	49,1	59,0
MOSA	mosaz antik	CVX0627AMA	1290,-	1561,-	54,9	65,9

Madlo 861

Povrch	typ provedení	obj. číslo kus	CZK	s DPH	EUR	s DPH
IN	nerez - levé	CVX0861LE	6795,-	8221,-	289,1	347,0
IN	nerez - pravé	CVX0861PE	6795,-	8221,-	289,1	347,0

Madlo 883

Povrch	typ provedení	obj. číslo kus	CZK	s DPH	EUR	s DPH
ONS	celková délka 250	CVX08836MA0250	1820,-	2202,-	77,4	92,9
ONS	celková délka 500	CVX08836MA0500	3210,-	3884,-	136,6	163,9

Madlo 931

Povrch	typ provedení	obj. číslo kus	CZK	s DPH	EUR	s DPH
IN	celková délka 400	CVX0931EMA0400	3425,-	4144,-	145,7	174,9
IN	celková délka 600	CVX0931EMA0600	3745,-	4531,-	159,4	191,2
IN	celková délka 800	CVX0931EMA0800	4600,-	5566,-	195,7	234,9

Madla Bregenz

Povrch	typ provedení	obj. číslo kus	CZK	s DPH	EUR	s DPH
K	kované kování	HA85201	2610,-	3158,-	111,1	133,3

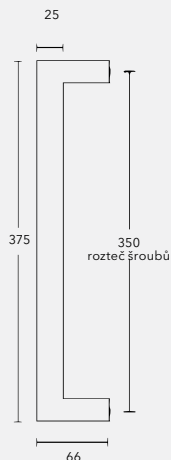

Madla Stein

Povrch	typ provedení	obj. číslo kus	CZK	s DPH	EUR	s DPH
K	kované kování	HA280370	2535,-	3067,-	107,9	129,4

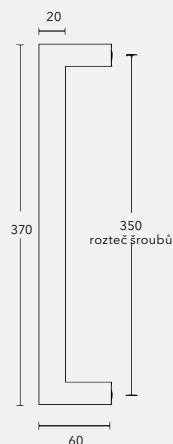

Madlo „na míru“

designový bezúdržbový způsob otevírání dveří

- zakázková nerezová madla
- volitelná délka a provedení
- profil 32mm, možné volit také hranaté provedení
- rozměry a cena mimo tabulku na vyžádání
- termín dodání 3 týdny

Jednostranná madla

Model	Osový rozměr (rozteč) mm	Oblý roh CZK bez DPH	Oblý roh CZK s DPH	Oblý roh EUR bez DPH	Oblý roh EUR s DPH	Ostrý roh CZK bez DPH	Ostrý roh CZK s DPH	Ostrý roh EUR bez DPH	Ostrý roh EUR s DPH
"U" 501 - 600	mm 500 - 600	1 853 Kč	2 242 Kč	78,9	94,3	3 023 Kč	3 657 Kč	128,6	154,3
"U" 601 - 700	mm 601 - 700	2 048 Kč	2 477 Kč	87,1	104,5	3 218 Kč	3 893 Kč	136,9	164,3
"U" 701 - 800	mm 701 - 800	2 243 Kč	2 713 Kč	95,4	114,5	3 413 Kč	4 129 Kč	145,2	174,2
"U" 801 - 900	mm 801 - 900	2 438 Kč	2 949 Kč	103,7	124,4	3 608 Kč	4 365 Kč	153,5	184,2
"U" 901 - 1000	mm 901 - 1000	2 633 Kč	3 185 Kč	112	134,4	3 803 Kč	4 601 Kč	161,8	194,2
"U" 1001 - 1100	mm 1001 - 1100	2 828 Kč	3 421 Kč	120,3	144,4	3 998 Kč	4 837 Kč	170,1	204,1
"U" 1101 - 1200	mm 1101 - 1200	3 023 Kč	3 657 Kč	128,6	154,3	4 193 Kč	5 073 Kč	178,4	214,1
"U" 1201 - 1300	mm 1201 - 1300	3 218 Kč	3 893 Kč	136,9	164,3	4 388 Kč	5 309 Kč	186,7	224,0
"U" 1301 - 1400	mm 1301 - 1400	3 413 Kč	4 129 Kč	145,2	174,2	4 583 Kč	5 545 Kč	195	234,0
"U" 1401 - 1500	mm 1401 - 1500	3 608 Kč	4 365 Kč	153,5	184,2	4 778 Kč	5 781 Kč	203,3	244,0
"U" 1501 - 1600	mm 1501 - 1600	3 803 Kč	4 601 Kč	161,8	194,2	4 973 Kč	6 017 Kč	211,6	253,9
"U" 1601 - 1700	mm 1601 - 1700	3 998 Kč	4 837 Kč	170,1	204,1	5 168 Kč	6 253 Kč	219,9	263,9
"U" 1701 - 1800	mm 1701 - 1800	4 193 Kč	5 073 Kč	178,4	214,1	5 363 Kč	6 489 Kč	228,2	273,8
"U" 1801 - 1900	mm 1801 - 1900	4 388 Kč	5 309 Kč	186,7	224,0	5 558 Kč	6 725 Kč	236,5	283,8
"U" 1901 - 2000	mm 1901 - 2000	4 583 Kč	5 545 Kč	195	234,0	5 753 Kč	6 961 Kč	244,8	293,8

Model	Osový rozměr (rozteč) mm	CZK bez DPH	CZK s DPH	EUR bez DPH	EUR s DPH
"F1" 501 - 600	mm 301-400	2 925 Kč	3 539 Kč	124,5	149,4
"F1" 601 - 700	mm 401-500	3 071 Kč	3 716 Kč	130,7	156,8
"F1" 701 - 800	mm 501-600	3 218 Kč	3 893 Kč	136,9	164,3
"F1" 801 - 900	mm 604-700	3 364 Kč	4 070 Kč	143,1	171,8
"F1" 901 - 1000	mm 701-800	3 510 Kč	4 247 Kč	149,4	179,2
"F1" 1001 - 1100	mm 801-900	3 656 Kč	4 424 Kč	155,6	186,7
"F1" 1101 - 1200	mm 901-1000	3 803 Kč	4 601 Kč	161,8	194,2
"F1" 1201 - 1300	mm 1001-1100	3 900 Kč	4 719 Kč	166,0	199,1
"F1" 1301 - 1400	mm 1101 - 1200	3 998 Kč	4 837 Kč	170,1	204,2
"F1" 1401 - 1500	mm 1201 - 1300	4 095 Kč	4 955 Kč	174,3	209,1
"F1" 1501 - 1600	mm 1301 - 1400	4 193 Kč	5 073 Kč	178,4	214,1
"F1" 1601 - 1700	mm 1401 - 1500	4 290 Kč	5 191 Kč	182,6	219,1
"F1" 1701 - 1800	mm 1501 - 1600	4 388 Kč	5 309 Kč	186,7	224,1
"F1" 1801 - 1900	mm 1601 - 1700	4 485 Kč	5 427 Kč	190,9	229,0
"F1" 1901 - 2000	mm 1701 - 1800	4 583 Kč	5 545 Kč	195,0	234,0



Madlo „na míru“

Oboustranná madla

Model	Osový rozměr (rozteč) mm	Oblý roh CZK bez DPH	Oblý roh CZK s DPH	Oblý roh EUR bez DPH	Oblý roh EUR s DPH	Ostrý roh CZK bez DPH	Ostrý roh CZK s DPH	Ostrý roh EUR bez DPH	Ostrý roh EUR s DPH
"U" 501 - 600 mm	500 - 600	2 470 Kč	2 989 Kč	105,1	126,1	4 030 Kč	4 876 Kč	171,5	205,8
"U" 601 - 700 mm	601 - 700	2 730 Kč	3 303 Kč	116,2	139,4	4 290 Kč	5 191 Kč	182,6	219,1
"U" 701 - 800 mm	701 - 800	2 990 Kč	3 618 Kč	127,2	152,7	4 550 Kč	5 506 Kč	193,6	232,3
"U" 801 - 900 mm	801 - 900	3 250 Kč	3 933 Kč	138,3	166,0	4 810 Kč	5 820 Kč	204,7	245,6
"U" 901 - 1000 mm	901 - 1000	3 510 Kč	4 247 Kč	149,4	179,2	5 070 Kč	6 135 Kč	215,7	258,9
"U" 1001 - 1100 mm	1001 - 1100	3 770 Kč	4 562 Kč	160,4	192,5	5 330 Kč	6 449 Kč	226,8	272,2
"U" 1101 - 1200 mm	1101 - 1200	4 030 Kč	4 876 Kč	171,5	205,8	5 590 Kč	6 764 Kč	237,9	285,4
"U" 1201 - 1300 mm	1201 - 1300	4 290 Kč	5 191 Kč	182,6	219,1	5 850 Kč	7 079 Kč	248,9	298,7
"U" 1301 - 1400 mm	1301 - 1400	4 550 Kč	5 506 Kč	193,6	232,3	6 110 Kč	7 393 Kč	260,0	312,0
"U" 1401 - 1500 mm	1401 - 1500	4 810 Kč	5 820 Kč	204,7	245,6	6 370 Kč	7 708 Kč	271,1	325,3
"U" 1501 - 1600 mm	1501 - 1600	5 070 Kč	6 135 Kč	215,7	258,9	6 630 Kč	8 022 Kč	282,1	338,6
"U" 1601 - 1700 mm	1601 - 1700	5 330 Kč	6 449 Kč	226,8	272,2	6 890 Kč	8 337 Kč	293,2	351,8
"U" 1701 - 1800 mm	1701 - 1800	5 590 Kč	6 764 Kč	237,9	285,4	7 150 Kč	8 652 Kč	304,3	365,1
"U" 1801 - 1900 mm	1801 - 1900	5 850 Kč	7 079 Kč	248,9	298,7	7 410 Kč	8 966 Kč	315,3	378,4
"U" 1901 - 2000 mm	1901 - 2000	6 110 Kč	7 393 Kč	260,0	312,0	7 670 Kč	9 281 Kč	326,4	391,7

Model	Osový rozměr (rozteč) mm	CZK bez DPH	CZK s DPH	EUR bez DPH	EUR s DPH
"F1" 501 - 600 mm	301-400	3 900 Kč	4 719 Kč	166,0	199,1
"F1" 601 - 700 mm	401-500	4 095 Kč	4 955 Kč	174,3	209,1
"F1" 701 - 800 mm	501-600	4 290 Kč	5 191 Kč	182,6	219,1
"F1" 801 - 900 mm	604-700	4 485 Kč	5 427 Kč	190,9	229,0
"F1" 901 - 1000 mm	701-800	4 680 Kč	5 663 Kč	199,1	239,0
"F1" 1001 - 1100 mm	801-900	4 875 Kč	5 899 Kč	207,4	248,9
"F1" 1101 - 1200 mm	901-1000	5 070 Kč	6 135 Kč	215,7	258,9
"F1" 1201 - 1300 mm	1001-1100	5 200 Kč	6 292 Kč	221,3	265,5
"F1" 1301 - 1400 mm	1101 - 1200	5 330 Kč	6 449 Kč	226,8	272,2
"F1" 1401 - 1500 mm	1201 - 1300	5 460 Kč	6 607 Kč	232,3	278,8
"F1" 1501 - 1600 mm	1301 - 1400	5 590 Kč	6 764 Kč	237,9	285,4
"F1" 1601 - 1700 mm	1401 - 1500	5 720 Kč	6 921 Kč	243,4	292,1
"F1" 1701 - 1800 mm	1501 - 1600	5 850 Kč	7 079 Kč	248,9	298,7
"F1" 1801 - 1900 mm	1601 - 1700	5 980 Kč	7 236 Kč	254,5	305,4
"F1" 1901 - 2000 mm	1701 - 1800	6 110 Kč	7 393 Kč	260,0	312,0



Posuvný systém

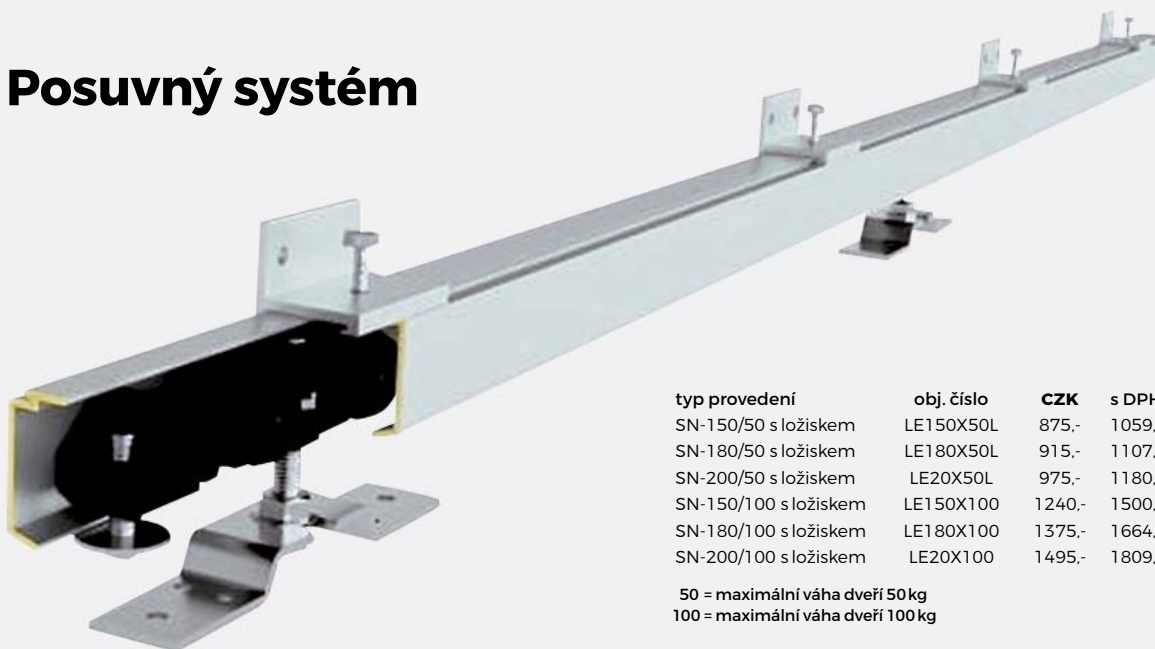

typ provedení	obj. číslo	CZK	s DPH	EUR	s DPH
SN-150/50 s ložiskem	LE150X50L	875,-	1059,-	37,2	44,7
SN-180/50 s ložiskem	LE180X50L	915,-	1107,-	38,9	46,7
SN-200/50 s ložiskem	LE20X50L	975,-	1180,-	41,5	49,8
SN-150/100 s ložiskem	LE150X100	1240,-	1500,-	52,8	63,3
SN-180/100 s ložiskem	LE180X100	1375,-	1664,-	58,5	70,2
SN-200/100 s ložiskem	LE20X100	1495,-	1809,-	63,6	76,3

50 = maximální váha dveří 50 kg
100 = maximální váha dveří 100 kg

Náprstky MT, MQ

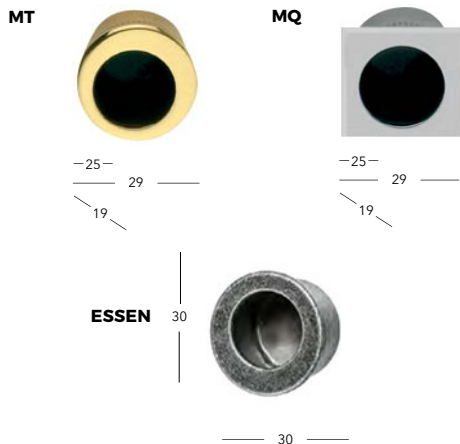

cena za kus

Povrch typ provedení	obj. číslo	CZK	s DPH	EUR	s DPH
OCS Náprstek MT kulatá	P14909X03N	74,-	89,-	3,1	3,8
OC Náprstek MT kulatá	P14905X03N	74,-	89,-	3,1	3,8
OFS Náprstek MT kulatá	P14908X03N	74,-	89,-	3,1	3,8
OLV Náprstek MT kulatá	P14902X03N	74,-	89,-	3,1	3,8
OCS Náprstek MQ hranatá	P14909HX03N	85,-	102,-	3,6	4,3
OC Náprstek MQ hranatá	P14905HX03N	85,-	102,-	3,6	4,3
OLV Náprstek MQ hranatá	P14902HX03N	85,-	102,-	3,6	4,3
K Náprstek Essen	HA37000	325,-	393,-	13,8	16,6

Úchyt 3663

Narážecí ovál

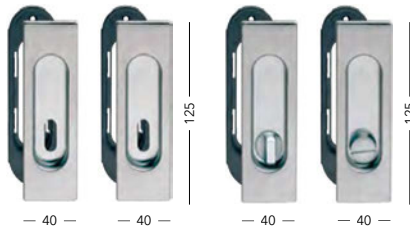

Pružinová bez otvoru



Povrch typ provedení	obj. číslo	CZK	s DPH	EUR	s DPH
IN 3663 bez otvoru pár	P1790EHX03PAR	440,-	532,-	18,7	22,5
OCS 3663 bez otvoru pár	P17909HX03PAR	440,-	532,-	18,7	22,5
OC 3663 bez otvoru pár	P17905HX03PAR	440,-	532,-	18,7	22,5
ONS 3663 bez otvoru pár	P17906HX03PAR	440,-	532,-	18,7	22,5
OFS 3663 bez otvoru pár	P17908HX03PAR	440,-	532,-	18,7	22,5
OLV 3663 bez otvoru pár	P17902HX03PAR	440,-	532,-	18,7	22,5
OCS 3663 BB pár	P17909HX13PAR	440,-	532,-	19,1	23,0
OC 3663 BB pár	P17905HX13PAR	440,-	532,-	19,1	23,0
ONS 3663 BB pár	P17906HX13PAR	440,-	532,-	19,1	23,0
OFS 3663 BB pár	P17908HX13PAR	440,-	532,-	19,1	23,0
OLV 3663 BB pár	P16902HX13PAR	440,-	532,-	19,1	23,0
OCS 3663 WC set	P17909HX3312PAR	655,-	793,-	27,9	33,4
OC 3663 WC set	P17905HX3312PAR	655,-	793,-	27,9	33,4
ONS 3663 WC set	P17906HX3312PAR	655,-	793,-	27,9	33,4
OFS 3663 WC set	P17908HX3312PAR	655,-	793,-	27,9	33,4
OLV 3663 WC set	P17902HX3312PAR	655,-	793,-	27,9	33,4
OCS 3663 pruž. bez otv. pár	P17909HPRX03PAR	740,-	895,-	31,5	37,8
OC 3663 pruž. bez otv. pár	P17905HPRX03PAR	740,-	895,-	31,5	37,8
ONS 3663 pruž. bez otv. pár	P17906HPRX03PAR	740,-	895,-	31,5	37,8
OFS 3663 pruž. bez otv. pár	P17908HPRX03PAR	740,-	895,-	31,5	37,8
OLV 3663 pruž. bez otv. pár	P17902PRX03PAR	740,-	895,-	31,5	37,8

Úchyt 3665

Narážecí ovál

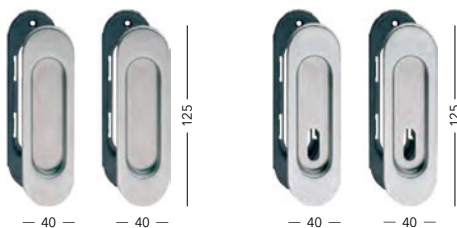

Pružinová bez otvoru



Povrch typ provedení	obj. číslo	CZK	s DPH	EUR	s DPH
OFS 3665 bez otvoru pár	P17908X03PAR	385,-	466,-	16,4	19,7
IN 3665 bez otvoru pár	P1790EX03PAR	385,-	466,-	16,4	19,7
OCS 3665 bez otvoru pár	P17909X03PAR	385,-	466,-	16,4	19,7
OC 3665 bez otvoru pár	P17905X03PAR	385,-	466,-	16,4	19,7
OLV 3665 bez otvoru pár	P17902X03PAR	385,-	466,-	16,4	19,7
OC 3665 BB pár	P17909X23PAR	395,-	478,-	16,8	20,2
OC 3665 BB pár	P17905X23PAR	395,-	478,-	16,8	20,2
ONS 3665 BB pár	P17906X23PAR	395,-	478,-	16,8	20,2
OFS 3665 BB pár	P17908X23PAR	395,-	478,-	16,8	20,2
OLV 3665 BB pár	P17902X23PAR	395,-	478,-	16,8	20,2
OCS 3665 WC set	P17909X3312PAR	630,-	762,-	26,8	32,2
OC 3665 WC set	P17905X3312PAR	630,-	762,-	26,8	32,2
ONS 3665 WC set	P17906X3312PAR	630,-	762,-	26,8	32,2
OFS 3665 WC set	P17908X3312PAR	630,-	762,-	26,8	32,2
OLV 3665 WC set	P17902X3312PAR	630,-	762,-	26,8	32,2
OCS 3665 pruž. bez otv. pár	P17909PRX03PAR	695,-	841,-	29,6	35,5
OC 3665 pruž. bez otv. pár	P17905PRX03PAR	695,-	841,-	29,6	35,5
ONS 3665 pruž. bez otv. pár	P17906PRX03PAR	695,-	841,-	29,6	35,5
OFS 3665 pruž. bez otv. pár	P17908PRX03PAR	695,-	841,-	29,6	35,5
OLV 3665 pruž. bez otv. pár	P17902PRX03PAR	695,-	841,-	29,6	35,5

Úchyt 3666 Kulatá

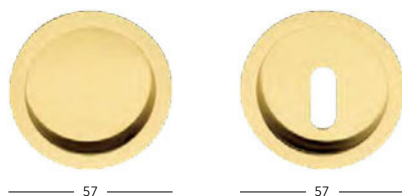

Povrch	typ provedení	obj. číslo	CZK	s DPH	EUR	s DPH
OCS	3666 bez otvoru pár	P16909X03PAR	255,-	309,-	10,9	13,0
OC	3666 bez otvoru pár	P16905X03PAR	255,-	309,-	10,9	13,0
ONS	3666 bez otvoru pár	P16906X03PAR	255,-	309,-	10,9	13,0
OFS	3666 bez otvoru pár	P16908X03PAR	255,-	309,-	10,9	13,0
OLV	3666 bez otvoru pár	P16902X03PAR	255,-	309,-	10,9	13,0
OCS	3666 BB pár	P16909X13PAR	280,-	339,-	11,9	14,3
OC	3666 BB pár	P16905X13PAR	280,-	339,-	11,9	14,3
ONS	3666 BB pár	P16906X13PAR	280,-	339,-	11,9	14,3
OFS	3666 BB pár	P16908X13PAR	280,-	339,-	11,9	14,3
OLV	3666 BB pár	P16902X13PAR	280,-	339,-	11,9	14,3
OCS	3666 WC set	P16909X3312PAR	440,-	532,-	18,7	22,5
OC	3666 WC set	P16905X3312PAR	440,-	532,-	18,7	22,5
ONS	3666 WC set	P16906X3312PAR	440,-	532,-	18,7	22,5
OFS	3666 WC set	P16908X3312PAR	440,-	532,-	18,7	22,5
OLV	3666 WC set	P16902X3312PAR	440,-	532,-	18,7	22,5

Úchyt 3667 Hranatá

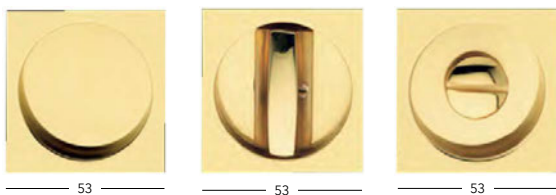

Povrch	typ provedení	obj. číslo	CZK	s DPH	EUR	s DPH
OCS	3667 bez otvoru pár	P16909HX03PAR	330,-	399,-	14,0	16,9
OC	3667 bez otvoru pár	P16905HX03PAR	330,-	399,-	14,0	16,9
ONS	3667 bez otvoru pár	P16906HX03PAR	330,-	399,-	14,0	16,9
OFS	3667 bez otvoru pár	P16908HX03PAR	330,-	399,-	14,0	16,9
OLV	3667 bez otvoru pár	P16902HX03PAR	330,-	399,-	14,0	16,9
OCS	3667 BB pár	P16909HX13PAR	355,-	430,-	15,1	18,1
OC	3667 BB pár	P16905HX13PAR	355,-	430,-	15,1	18,1
ONS	3667 BB pár	P16906HX13PAR	355,-	430,-	15,1	18,1
OFS	3667 BB pár	P16908HX13PAR	355,-	430,-	15,1	18,1
OLV	3667 BB pár	P16902HX13PAR	355,-	430,-	15,1	18,1
OCS	3667 WC set	P16909HX3312PAR	490,-	593,-	20,9	25,0
OC	3667 WC set	P16905HX3312PAR	490,-	593,-	20,9	25,0
ONS	3667 WC set	P16906HX3312PAR	490,-	593,-	20,9	25,0
OFS	3667 WC set	P16908HX3312PAR	490,-	593,-	20,9	25,0
OLV	3667 WC set	P16902HX3312PAR	490,-	593,-	20,9	25,0

Úchyty

cena za kus

Povrch	typ provedení	obj. číslo	CZK	s DPH	EUR	s DPH
IN	Úchyt pos. dveře A	C160EXA	215,-	260,-	9,1	11,0
IN	Úchyt pos. dveře B	C160EXB	140,-	169,-	6,0	7,1
IN	Úchyt pos. dveře C	C160EXC	150,-	181,-	6,4	7,6
IN	Úchyt pos. dveře D	C160EXD	326,-	395,-	13,9	16,7
IN	Úchyt pos. dveře E	C160EXE	140,-	169,-	6,0	7,1

posuvné dveře A

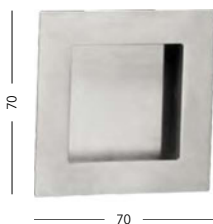

posuvné dveře B

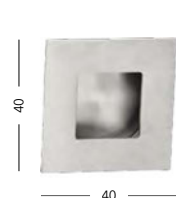

posuvné dveře C



posuvné dveře D

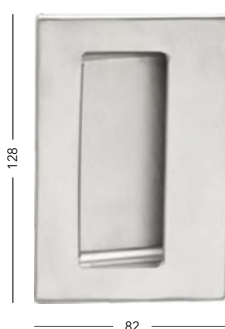

posuvné dveře E



82

Úchytky

Hloubka 12 mm

Hranatá bez otvoru

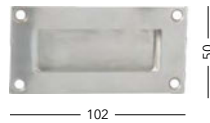

Ovál bez otvoru

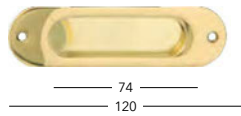

Ovál WC vnitřní

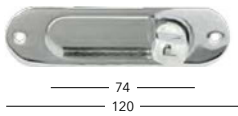

Ovál BB



Ovál WC vnější

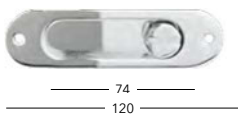

Hranatá bez otvoru



cena za kus

Povrch typ provedení

Povrch typ provedení	obj. číslo	CZK	s DPH	EUR	s DPH
IN Hranatá bez otvoru	C1592EX03	205,-	248	8,7	10,5
IN Ovál bez otvoru	C1591EX03	205,-	248	8,7	10,5
OCS Ovál bez otvoru	P15909X03P	220,-	266	9,4	11,2
OC Ovál bez otvoru	P15905X03P	220,-	266	9,4	11,2
ONS Ovál bez otvoru	P15906X03P	220,-	266	9,4	11,2
OFS Ovál bez otvoru	P15907X03P	220,-	266	9,4	11,2
OLV Ovál bez otvoru	P15902X03P	220,-	266	9,4	11,2
OCS Ovál BB	P15909X13P	220,-	266	9,4	11,2
OC Ovál BB	P15905X13P	220,-	266	9,4	11,2
ONS Ovál BB	P15906X13P	220,-	266	9,4	11,2
OFS Ovál BB	P15907X13P	220,-	266	9,4	11,2
OLV Ovál BB	P15902X13P	220,-	266	9,4	11,2
OCS Ovál WC vnitřní	P15909X331P	315,-	381,-	13,4	16,1
OCS Ovál WC vnější	P15909X332P	315,-	381,-	13,4	16,1
OC Ovál WC vnitřní	P15905X331P	315,-	381,-	13,4	16,1
OC Ovál WC vnější	P15905X332P	315,-	381,-	13,4	16,1
ONS Ovál WC vnitřní	P15906X331P	315,-	381,-	13,4	16,1
ONS Ovál WC vnější	P15906X332P	315,-	381,-	13,4	16,1
OFS Ovál WC vnitřní	P15907X331P	315,-	381,-	13,4	16,1
OFS Ovál WC vnější	P15907X332P	315,-	381,-	13,4	16,1
OLV Ovál WC vnitřní	P15902X331P	315,-	381,-	13,4	16,1
OLV Ovál WC vnější	P15902X332P	315,-	381,-	13,4	16,1

cena za kus

Povrch typ provedení

Povrch typ provedení	obj. číslo	CZK	s DPH	EUR	s DPH
IN Úchytky 120x50mm bez otvoru	A23601	180,-	218,-	7,7	9,2
IN Úchytky 150x50mm bez otvoru	A23602	205,-	248,-	8,7	10,4
IN Úchytky 180x60mm bez otvoru	A23603	230,-	278,-	9,8	11,8

Úchytky Kované

cena za kus

Povrch typ provedení	obj. číslo	CZK	s DPH	EUR	s DPH
K Ovál 001	HA217001	325,-	393,-	13,8	16,6
K Ovál 003	HA217003	400,-	484,-	17,0	20,4
K Ovál 004	HA217004	400,-	484,-	17,0	20,4
K Nurnberg ovál	HA36000	500,-	605,-	21,3	25,5
K Ulmen hranatý	HA300UCH	870,-	1 053,-	37,0	44,4

001



003



004



Nurnberg



Ulmen



DOPLŇKY

Doplňky

ACCESSORIES

- | | | | | | |
|-----|---------------------------------|-----|--------------------------------|-----|------------------|
| 136 | Balkónové kliky | 146 | Drobný spojovací materiál | 153 | Vhozy na dopisy |
| 137 | Kovaná posuvná klika Steinacht | 147 | Křbové nářadí / Dětský program | 154 | Věšáky a konzole |
| 138 | Cylindrické vložky | 148 | Panikové kování | 156 | Zadlabací zámky |
| 142 | Číslice a piktogramy / klepadla | 150 | Rozety / montážní šablony | 157 | Závěsy |
| 144 | Dorazy, stavěče, zarážky | 151 | Prahové lišty | | |
| 145 | Řetízky, kukátka | 151 | Samozavírače | | |
| 146 | Držáky zábradlí | 153 | Větrací mřížky | | |





Balkónové kliky



Název	CZK	s DPH	EUR	s DPH
1555	1700,-	2057,-	72,3	86,8
Element	375,-	453,-	15,9	19,1
Gabri	510,-	617,-	21,7	26,0
Mega	425,-	514,-	18,1	21,7
Orion	315,-	381,-	13,4	16,1

„Informujte se u vašeho prodejce na možnost kompletace balkonové kliky z jakékoliv interiérové v tomto katalogu dle vašeho výběru“



Název	CZK	s DPH	EUR	s DPH
ST1	140,-	169,-	6,0	7,1
ST5-F1	115,-	139,-	4,9	5,9
ST5-F1 pojistka	370,-	448,-	15,7	18,9
ST5-F1 uzamykatelná	455,-	550,-	19,4	23,2
ST5-F4	125,-	151,-	5,3	6,4
ST5-F4 pojistka	410,-	496,-	17,4	20,9
ST5-F4 uzamykatelná	455,-	550,-	19,4	23,2
ST5-F9	125,-	151,-	5,3	6,4
ST5-F9 pojistka	410,-	496,-	17,4	20,9
ST5-F9 uzamykatelná	455,-	550,-	19,4	23,2



Název	CZK	s DPH	EUR	s DPH
ST6-antracit	80,-	97,-	3,4	4,1
ST6-bílá	70,-	84,-	3,0	3,6
ST6-bílá uzamykatelná	210,-	254,-	8,9	10,7
ST6-hnědá	70,-	84,-	3,0	3,6
ST6-satén	80,-	97,-	3,4	4,1
ST6-titan	80,-	97,-	3,4	4,1
ST6-zlatá	80,-	97,-	3,4	4,1
ST6-zlatý dub	80,-	97,-	3,4	4,1
ST7-bílá	60,-	73,-	2,6	3,1
ST8-bílá plast	40,-	48,-	1,7	2,0



Balkónové kliky

Innsbruck HR



Innsbruck HR se zámkem



Innsbruck OVÁL



Innsbruck OVÁL se zámkem



Název	CZK	s DPH	EUR	s DPH
Innsbruck HR	1985,-	2402,-	84,5	101,4
Innsbruck HR se zámkem	3610,-	4368,-	153,6	184,3
Innsbruck OVÁL	1985,-	2402,-	84,5	101,4
Innsbruck OVÁL se zámkem	3610,-	4368,-	153,6	184,3

K

Kovaná posuvná klika / mušle

Steinacht



120

40

10

CZK	s DPH	EUR	s DPH
6795,-	8222,-	289,1	347,0

K



Cylindrické vložky

EURO X Star



Certifikováno v bezpečnostní třídě RC4 dle ČSN EN 1627:2012.

Bezpečnostní 10-ti stavítková vložka s ocelovou tyčí proti rozlomení. Ochrana proti vyhmátání a bumpingu. Možnost společného uzávěru - SU.

430.000 reálných kombinací klíče.
Materiál vložky a klíče: **mosaz**
Povrchová úprava: **nikl matný**

Obsahuje:

6 ks prodloužených oboustraných klíčů
2 ks šroubů 50+60mm
identifikační kartu



Možnost objednání s knoflíkem.

EURO Secure



Certifikováno v bezpečnostní třídě RC3 dle ČSN EN 1627:2012.
Certifikát NBÚ typ 2SS4=2

Bezpečnostní 6-ti stavítková vložka s odolností proti odvrtání a nedestruktivní dynamické metodě (tzv. bumping) Možnost společného uzávěru - SU.

40.000 reálných kombinací klíče.
Materiál vložky a klíče: **mosaz**
Povrchová úprava: **nikl matný, mosaz matná**

Obsahuje:

6 ks prodloužených klíčů
2 ks šroubů 50+60mm
identifikační kartu



Možnost objednání s knoflíkem.

EURO Plus

Certifikováno dle EN 1303:2005.

Stavební 5-ti stavítková vložka.
Materiál vložky a klíče: **mosaz**
Povrchová úprava: **nikl matný**
Možnost společného uzávěru - SU.

Obsahuje:

3 ks klíčů
2 ks šroubů 50+60mm



Možnost objednání s knoflíkem.

EURO Zero

Stavební 5 stavítková vložka

Materiál vložky a klíče: **slitina zinku**
Povrchová úprava: **nikl matný**
Možnost společného uzávěru - SU.

Obsahuje:

3 ks klíčů
1 ks šroubů 50 mm



CZK / s DPH

Rozměr	30/30.NI	30/35.NI	30/35.MS	30/35.BR	30/40.NI	30/45.NI	30/50.NI	30/55.NI	30/60.NI	30/65.NI	30/70.NI	35/35.NI	35/40.NI	35/45.NI
EURO XStar	575 / 696	575 / 696	x	x	605 / 732	635 / 768	665 / 805	695/841	725/877	x	x	605 / 732	635 / 768	665/805
EURO Secure	280 / 339	300 / 363	290 / 351	x	320 / 387	340 / 411	350 / 424	380 / 460	400 / 484	420 / 508	440 / 532	320 / 387	340 / 411	360 / 436
EURO Plus	150 / 182	149 / 180	143 / 173	165 / 200	190 / 230	205 / 248	215 / 260	230/278	245/296	x	x	190 / 230	205 / 248	215 / 260
EURO Zero	x	98 / 119	98 / 119	x	x	x	x	x	x	x	x	x	x	x

Rozměr	35/50.NI	35/55.NI	35/60.IN	35/65.NI	40/40.NI	40/45.NI	40/50.NI	40/55.NI	40/60.NI	45/45.NI	45/50.IN	45/55.NI	50/50.NI	40/65.NI
EURO XStar	695/841	725/877	755/914	775/938	665 / 805	695 / 841	725 / 877	755/914	775/938	725/877	755 / 914	775/938	775/938	795/962
EURO Secure	380 / 460	400 / 484	420 / 508	440 / 532	360 / 436	380 / 460	400 / 484	420 / 508	440 / 532	400 / 484	420 / 508	440 / 532	440 / 532	500 / 605
EURO Plus	230 / 278	245 / 296	x	x	215 / 260	230 / 278	245 / 296	260 / 315	x	245 / 296	260 / 315	x	x	x

Rozměr	40/70.NI	45/60.NI	45/70.NI	50/55.NI	50/60.NI	55/55.NI	55/60.MS	60/60.BR	0/30.NI
EURO XStar	815/986	795/962	x	x	815/986	x	x	x	x
EURO Secure	520 / 629	500 / 605	540 / 653	500 / 605	520 / 629	520 / 629	540 / 653	560 / 678	250 / 303
EURO Plus	x	x	x	x	x	x	x	x	135 / 163

EUR / s DPH

Rozměr	30/30.NI	30/35.NI	30/35.MS	30/35.BR	30/40.NI	30/45.NI	30/50.NI	30/55.NI	30/60.NI	30/65.NI	30/70.NI	35/35.NI	35/40.NI	35/45.NI
EURO XStar	24,5/29,4	24,5/29,4	x	x	25,7/30,9	27,0/32,4	28,3/34,0	29,6/35,5	30,9/37,0	x	x	25,7/30,8	27,0/32,4	28,3/34,0
EURO Secure	11,9 / 14,3	12,8 / 15,3	12,3 - 14,8	x	13,6 / 16,3	14,5 / 17,4	14,9 / 17,9	16,2 / 19,4	17,0 / 20,4	17,9 / 21,5	18,7 / 22,4	13,6 / 16,3	13,6 / 16,3	13,6 / 16,3
EURO Plus	6,4 / 7,7	6,3 / 7,6	6 / 7,2	7 / 8,4	8 / 9,6	8,7 / 10,4	9,1 / 10,9	9,8 / 11,8	10,4 / 12,5	x	x	8 / 9,6	8,7 / 10,4	9,1 / 10,9
EURO Zero	x	4,2 / 5,0	4,2 / 5,0	x	x	x	x	x	x					

Rozměr	35/50.NI	35/55.NI	35/60.IN	35/65.NI	40/40.NI	40/45.NI	40/50.NI	40/55.NI	40/60.NI	45/45.NI	45/50.IN	45/55.NI	50/50.NI	40/65.NI
EURO XStar	29,6/35,5	30,9/37,0	32,1/38,6	33,0/39,6	28,3/34,0	29,6/35,5	30,9/37,0	32,1/38,6	33,0/39,6	30,9/37,0	32,1/38,6	33,0/39,6	33,0/39,6	33,8/40,6
EURO Secure	16,2/19,4	17,0/20,4	17,0/20,4	18,7/22,5	15,3/18,4	16,2/19,4	17,0/20,4	17,9/21,4	18,7/22,5	17/20,4	17,9/21,4	18,7/22,5	18,7/22,5	21,3/25,5
EURO Plus	9,8/11,8	10,4/12,5	x	x	9,1/10,9	9,8/11,8	10,4/12,5	11/13,2	x	10,4/12,5	11/13,2	x	x	x

Rozměr	40/70.NI	45/60.NI	45/70.NI	50/55.NI	50/60.NI	55/55.NI	55/60.MS	60/60.BR	0/30.NI
EURO XStar	34,7/41,6	33,8/40,6	x	x	34,7/41,6	x	x	x	x
EURO Secure	22,1/26,6	21,3/25,5	22,8/27,4	21,3/25,5	22,1/26,6	22,1/26,6	23,0/27,6	23,8/28,6	10,4/12,5
EURO Plus	x	x	x	x	x	x	x	x	5,7/6,8

Příplatky za přestavbu

	knoflík	přestavba	PS	klíč
Euro zero	x	x	x	39
Euro minus	x	200	x	39
Euro plus	260	200	x	39
Euro secure	260	220	260	59
Euro xstar	260	250	260	160



Knoflík - ani jedna strana nesmí být delší než 55mm.

PS - Prostupová spojka je doplňkový mechanismus vložky, který umožňuje ovládat vložku, i když je na protilehlé straně zasunutý klíč. Ani jedna strana nesmí být delší než 55mm.

System generálního klíče

System generálního klíče je způsob zabezpečení objektu, ve kterém je požadavek na omezení práv přístupu a je hojně využíván tam, kde je nutné přidělit prostřednictvím klíčových práv přístup do jednotlivých prostor daného objektu. V rámci systému generálního klíče obdrží každá osoba klíč, kterým si odemkne pouze přidělené vložky a zároveň neodemkne vložky, které přidělené nemá. V rámci systému generálního klíče se ale vždy generuje i zvláštní tzv. generální klíč, který odemkne veškeré zámky systému a který se používá při nenadálých situacích. Investor **specifikuje typ, rozměr a přístupová práva** k jednotlivým vstupům do elektronické tabulky.

Systemy generálního klíče se doporučují zejména pro použití v administrativních budovách, hotelích, sportovních centrech apod.

- generálním klíčem je možné otevřít všechny vložky v systému,
- hlavní klíč je klíč, kterým je možné otevřít určitou skupinu dveří,
- vlastní klíč otevírá pouze jednu cylindrickou vložku.

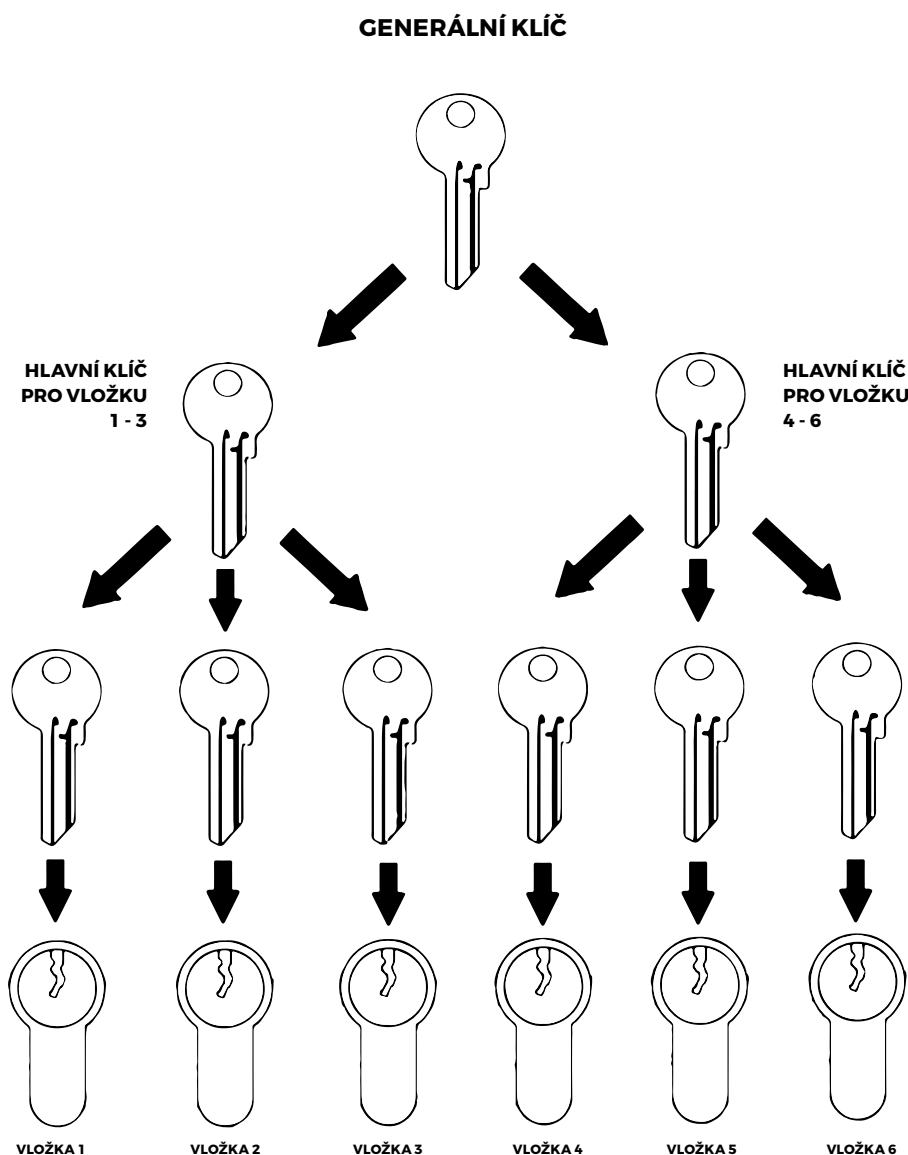

Společný (sjednocený) uzávěr

Sjednocení vložek je ideální řešení pro rodinné domy nebo firemní prostory, zkrátka tam, kde je mnoho uzamykatelných přístupů. Pro všechny vložky je možné využívat pouze jeden klíč. Při výrobě se použije vzorová vložka, podle které se vyrobí požadovaný počet dalších vložek. Vložky typu EUROSECURE mají v základu 6 klíčů a vložky EUROPLUS mají v základu 3 klíče. Investor **specifikuje typ vložky, rozměr vložek, počet vložek a celkový počet klíčů.**

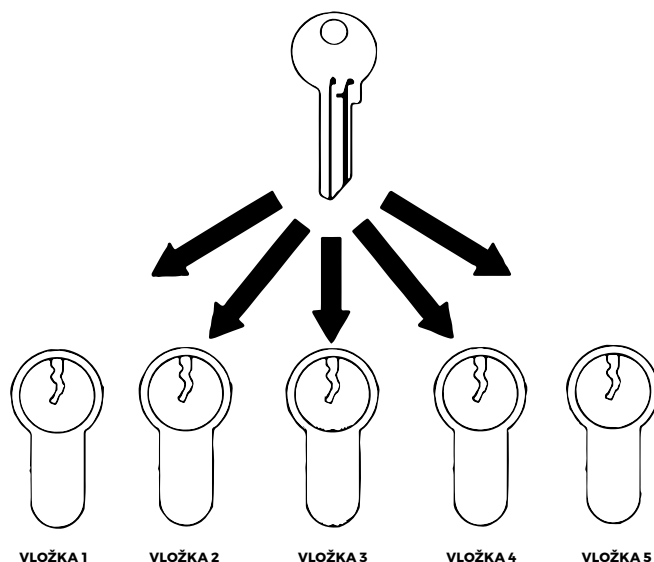

 3

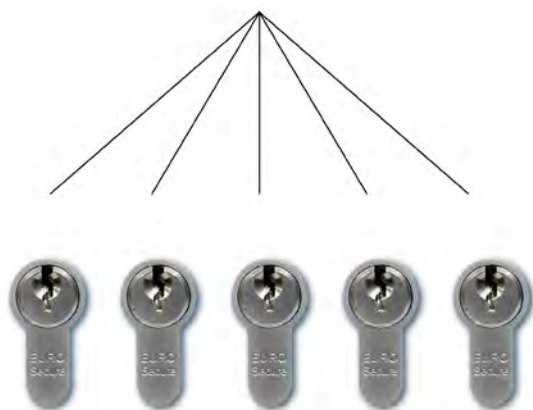

 4

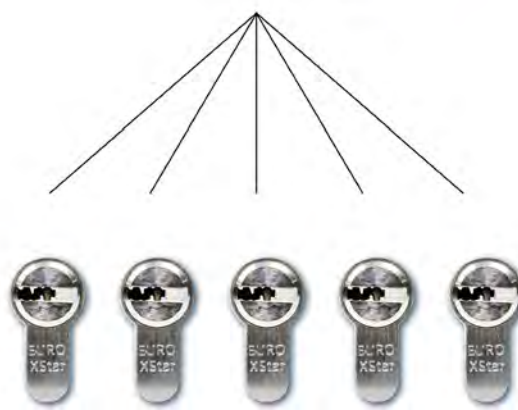

Piktogramy a číslice nalepovací

Povrch	typ provedení	obj. číslo	CZK	s DPH	EUR	s DPH
IN	Přebalovací pult	CPIBABY	145,-	175,-	6,2	7,4
IN	Dáma	CPIDAMA	145,-	175,-	6,2	7,4
IN	Pán	CPIPAN	145,-	175,-	6,2	7,4
IN	Invalidní	CPIINVAL	145,-	175,-	6,2	7,4
IN	Směr	CPISMER	145,-	175,-	6,2	7,4
IN	Sprcha	CPISPRCH	145,-	175,-	6,2	7,4
IN	Telefon	CPITELEF	145,-	175,-	6,2	7,4
IN	Zákaz kouření	CPINEKUR	145,-	175,-	6,2	7,4
IN	Wifi	CPIWIFI	145,-	175,-	6,2	7,4
IN	WC	CPIWC	145,-	175,-	6,2	7,4
IN	Monitorováno	CPMONIT	145,-	175,-	6,2	7,4
IN	Zákaz telefonování	CPZAKTEL	145,-	175,-	6,2	7,4

Povrch	typ provedení	obj. číslo	CZK	s DPH	EUR	s DPH
IN	.0" 25 mm	C2183E00	35,-	42,-	1,5	1,8
IN	.1" 25 mm	C2183E01	35,-	42,-	1,5	1,8
IN	.2" 25 mm	C2183E02	35,-	42,-	1,5	1,8
IN	.3" 25 mm	C2183E03	35,-	42,-	1,5	1,8
IN	.4" 25 mm	C2183E04	35,-	42,-	1,5	1,8
IN	.5" 25 mm	C2183E05	35,-	42,-	1,5	1,8
IN	.6" 25 mm	C2183E06	35,-	42,-	1,5	1,8
IN	.7" 25 mm	C2183E07	35,-	42,-	1,5	1,8
IN	.8" 25 mm	C2183E08	35,-	42,-	1,5	1,8
IN	.9" 25 mm	C2183E09	35,-	42,-	1,5	1,8
IN	./" 25 mm	C2183E10	35,-	42,-	1,5	1,8



— 80 —



Číslice a písmena nerez



Povrch	typ provedení	obj. číslo	CZK	s DPH	EUR	s DPH
IN	.0" 150x100x3 mm	C2180E00	146,-	176,-	6,2	7,4
IN	.1" 150x100x3 mm	C2180E01	146,-	176,-	6,2	7,4
IN	.2" 150x100x3 mm	C2180E02	146,-	176,-	6,2	7,4
IN	.3" 150x100x3 mm	C2180E03	146,-	176,-	6,2	7,4
IN	.4" 150x100x3 mm	C2180E04	146,-	176,-	6,2	7,4
IN	.5" 150x100x3 mm	C2180E05	146,-	176,-	6,2	7,4
IN	.6" 150x100x3 mm	C2180E06	146,-	176,-	6,2	7,4
IN	.7" 150x100x3 mm	C2180E07	146,-	176,-	6,2	7,4
IN	.8" 150x100x3 mm	C2180E08	146,-	176,-	6,2	7,4
IN	.9" 150x100x3 mm	C2180E09	146,-	176,-	6,2	7,4
IN	./" 150x100x3 mm	C2180E11	146,-	176,-	6,2	7,4

Číslice



Povrch	typ provedení	obj. číslo	CZK	s DPH	EUR	s DPH	Povrch	typ provedení	obj. číslo	CZK	s DPH	EUR	s DPH	Povrch	typ provedení	obj. číslo	CZK	s DPH	EUR	s DPH
ONS	.0" 50 mm	C2150N0	40,-	48,-	1,7	2,0	OLV	.0" 50 mm	C2150M0	40,-	48,-	1,7	2,0	OFS	.0" 100 mm	C2160B0	95,-	115,-	4,1	4,9
ONS	.1" 50 mm	C2150N1	40,-	48,-	1,7	2,0	OLV	.1" 50 mm	C2150M1	40,-	48,-	1,7	2,0	OFS	.1" 100 mm	C2160B1	95,-	115,-	4,1	4,9
ONS	.2" 50 mm	C2150N2	40,-	48,-	1,7	2,0	OLV	.2" 50 mm	C2150M2	40,-	48,-	1,7	2,0	OFS	.2" 100 mm	C2160B2	95,-	115,-	4,1	4,9
ONS	.3" 50 mm	C2150N3	40,-	48,-	1,7	2,0	OLV	.3" 50 mm	C2150M3	40,-	48,-	1,7	2,0	OFS	.3" 100 mm	C2160B3	95,-	115,-	4,1	4,9
ONS	.4" 50 mm	C2150N4	40,-	48,-	1,7	2,0	OLV	.4" 50 mm	C2150M4	40,-	48,-	1,7	2,0	OFS	.4" 100 mm	C2160B4	95,-	115,-	4,1	4,9
ONS	.5" 50 mm	C2150N5	40,-	48,-	1,7	2,0	OLV	.5" 50 mm	C2150M5	40,-	48,-	1,7	2,0	OFS	.5" 100 mm	C2160B5	95,-	115,-	4,1	4,9
ONS	.6" 50 mm	C2150N6	40,-	48,-	1,7	2,0	OLV	.6" 50 mm	C2150M6	40,-	48,-	1,7	2,0	OFS	.6" 100 mm	C2160B6	95,-	115,-	4,1	4,9
ONS	.7" 50 mm	C2150N7	40,-	48,-	1,7	2,0	OLV	.7" 50 mm	C2150M7	40,-	48,-	1,7	2,0	OFS	.7" 100 mm	C2160B7	95,-	115,-	4,1	4,9
ONS	.8" 50 mm	C2150N8	40,-	48,-	1,7	2,0	OLV	.8" 50 mm	C2150M8	40,-	48,-	1,7	2,0	OFS	.8" 100 mm	C2160B8	95,-	115,-	4,1	4,9
ONS	.9" 50 mm	C2150N9	40,-	48,-	1,7	2,0	OLV	.9" 50 mm	C2150M9	40,-	48,-	1,7	2,0	OFS	.9" 100 mm	C2160B9	95,-	115,-	4,1	4,9
ONS	./" 50 mm	C2150N/	40,-	48,-	1,7	2,0	OLV	./" 50 mm	C2150M/	40,-	48,-	1,7	2,0	OFS	./" 100 mm	C2160B/	95,-	115,-	4,1	4,9
OFS	.0" 50 mm	C2150B0	40,-	48,-	1,7	2,0	ONS	.0" 100 mm	C2160N0	95,-	115,-	4,1	4,9	OLV	.0" 100 mm	C2160M0	95,-	115,-	4,1	4,9
OFS	.1" 50 mm	C2150B1	40,-	48,-	1,7	2,0	ONS	.1" 100 mm	C2160N1	95,-	115,-	4,1	4,9	OLV	.1" 100 mm	C2160M1	95,-	115,-	4,1	4,9
OFS	.2" 50 mm	C2150B2	40,-	48,-	1,7	2,0	ONS	.2" 100 mm	C2160N2	95,-	115,-	4,1	4,9	OLV	.2" 100 mm	C2160M2	95,-	115,-	4,1	4,9
OFS	.3" 50 mm	C2150B3	40,-	48,-	1,7	2,0	ONS	.3" 100 mm	C2160N3	95,-	115,-	4,1	4,9	OLV	.3" 100 mm	C2160M3	95,-	115,-	4,1	4,9
OFS	.4" 50 mm	C2150B4	40,-	48,-	1,7	2,0	ONS	.4" 100 mm	C2160N4	95,-	115,-	4,1	4,9	OLV	.4" 100 mm	C2160M4	95,-	115,-	4,1	4,9
OFS	.5" 50 mm	C2150B5	40,-	48,-	1,7	2,0	ONS	.5" 100 mm	C2160N5	95,-	115,-	4,1	4,9	OLV	.5" 100 mm	C2160M5	95,-	115,-	4,1	4,9
OFS	.6" 50 mm	C2150B6	40,-	48,-	1,7	2,0	ONS	.6" 100 mm	C2160N6	95,-	115,-	4,1	4,9	OLV	.6" 100 mm	C2160M6	95,-	115,-	4,1	4,9
OFS	.7" 50 mm	C2150B7	40,-	48,-	1,7	2,0	ONS	.7" 100 mm	C2160N7	95,-	115,-	4,1	4,9	OLV	.7" 100 mm	C2160M7	95,-	115,-	4,1	4,9
OFS	.8" 50 mm	C2150B8	40,-	48,-	1,7	2,0	ONS	.8" 100 mm	C2160N8	95,-	115,-	4,1	4,9	OLV	.8" 100 mm	C2160M8	95,-	115,-	4,1	4,9
OFS	.9" 50 mm	C2150B9	40,-	48,-	1,7	2,0	ONS	.9" 100 mm	C2160N9	95,-	115,-	4,1	4,9	OLV	.9" 100 mm	C2160M9	95,-	115,-	4,1	4,9
							ONS	./" 100 mm	C2160N/	95,-	115,-	4,1	4,9	OLV	./" 100 mm	C2160M/	95,-	115,-	4,1	4,9

Číslice a písmena kovaná



Povrch	typ provedení	obj. číslo	CZK	s DPH	EUR	s DPH
K	.A" 120 mm	HA00A	325,-	393,-	13,8	16,6
K	.B" 120 mm	HA00B	325,-	393,-	13,8	16,6
K	.C" 120 mm	HA00C	325,-	393,-	13,8	16,6
K	.D" 120 mm	HA00D	325,-	393,-	13,8	16,6
K	.0" 120 mm	HA000	326,-	395,-	13,9	16,7
K	.1" 120 mm	HA001	326,-	395,-	13,9	16,7
K	.2" 120 mm	HA002	326,-	395,-	13,9	16,7
K	.3" 120 mm	HA003	326,-	395,-	13,9	16,7
K	.4" 120 mm	HA004	326,-	395,-	13,9	16,7
K	.5" 120 mm	HA005	326,-	395,-	13,9	16,7
K	.6" 120 mm	HA006	326,-	395,-	13,9	16,7
K	.7" 120 mm	HA007	326,-	395,-	13,9	16,7
K	.8" 120 mm	HA008	326,-	395,-	13,9	16,7
K	.9" 120 mm	HA009	326,-	395,-	13,9	16,7

Číslice a písmena nerez černá



Povrch	typ provedení	obj. číslo	CZK	s DPH	EUR	s DPH
ČERNÁ	.A" 150 mm	C2180B0A	145,-	175,-	6,2	7,4
ČERNÁ	.B" 150 mm	C2180B0B	145,-	175,-	6,2	7,4
ČERNÁ	.C" 150 mm	C2180B0C	145,-	175,-	6,2	7,4
ČERNÁ	.D" 150 mm	C2180B0D	145,-	175,-	6,2	7,4
ČERNÁ	.0" 150 mm	C2180B00	146,-	176,-	6,2	7,4
ČERNÁ	.1" 150 mm	C2180B01	146,-	176,-	6,2	7,4
ČERNÁ	.2" 150 mm	C2180B02	146,-	176,-	6,2	7,4
ČERNÁ	.3" 150 mm	C2180B03	146,-	176,-	6,2	7,4
ČERNÁ	.4" 150 mm	C2180B04	146,-	176,-	6,2	7,4
ČERNÁ	.5" 150 mm	C2180B05	146,-	176,-	6,2	7,4
ČERNÁ	.6" 150 mm	C2180B06	146,-	176,-	6,2	7,4
ČERNÁ	.7" 150 mm	C2180B07	146,-	176,-	6,2	7,4
ČERNÁ	.8" 150 mm	C2180B08	146,-	176,-	6,2	7,4
ČERNÁ	.9" 150 mm	C2180B09	146,-	176,-	6,2	7,4
ČERNÁ	./" 150 mm	C2180B09	146,-	176,-	6,2	7,4

Klepadla

Povrch	typ provedení	obj. číslo	CZK	s DPH	EUR	s DPH
OLV	Anello Ø 90 mm	BE01102C00	1290,-	1561,-	50,6	60,8
OLV	Anello Ø 110 mm	BE01102B00	1190,-	1440,-	54,9	65,9
K	Tirol Ø 65 mm	HA115006	1150,-	1392,-	48,9	58,7
K	Tirol Ø 85 mm	HA115002	1290,-	1561,-	54,9	65,9
OFS	Lev 150x90 mm	BE0158P00	1180,-	1428,-	50,2	60,3
OLV	Lev 150x90 mm	BE0152P00	1180,-	1428,-	50,2	60,3
OFS	Lev 190x110 mm	BE0158M00	1340,-	1621,-	57,0	68,4
OLV	Lev 190x110 mm	BE0152M00	1340,-	1621,-	57,0	68,4
OFS	Lev 260x150 mm	BE0158G00	1480,-	1791,-	63,0	75,6
OLV	Lev 260x150 mm	BE0152G00	1480,-	1791,-	63,0	75,6



Stavěč dveří



Povrch	typ provedení	obj. číslo	CZK	s DPH	EUR	s DPH
OC	Stavěč dveří 899	C8991310	96,-	117,-	4,1	4,9
BILÁ	Stavěč dveří 899	C8991320	96,-	117,-	4,1	4,9
OLV	Stavěč dveří 899	C8991330	96,-	117,-	4,1	4,9
Hnědá	Stavěč dveří 899	C8991340	96,-	117,-	4,1	4,9
ONS	Stavěč dveří 899	C8991350	96,-	117,-	4,1	4,9

Povrch	typ provedení	obj. číslo	CZK	s DPH	EUR	s DPH
OC	Stavěč dveří 898S	C8981310	107,-	129,-	4,6	5,5
BILÁ	Stavěč dveří 898S	C8981310	107,-	129,-	4,6	5,5
OLV	Stavěč dveří 898S	C8981310	107,-	129,-	4,6	5,5
Hnědá	Stavěč dveří 898S	C8981310	107,-	129,-	4,6	5,5
ONS	Stavěč dveří 898S	C8981310	107,-	129,-	4,6	5,5

Povrch	typ provedení	obj. číslo	CZK	s DPH	EUR	s DPH
OC	Stavěč dveří 898L	C8982810	119,-	144,-	5,1	6,1
OLV	Stavěč dveří 898L	C8982830	119,-	144,-	5,1	6,1
Hnědá	Stavěč dveří 898L	C8982840	119,-	144,-	5,1	6,1
ONS	Stavěč dveří 898L	C8982850	119,-	144,-	5,1	6,1

Zarážka dveří

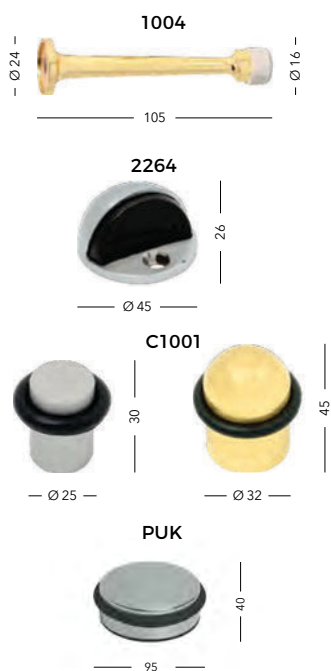

Povrch	typ provedení	obj. číslo	CZK	s DPH	EUR	s DPH
OCS	Zarážka dveří 1004	C10049X00	72,-	87,-	3,1	3,7
OC	Zarážka dveří 1004	C10045X00	72,-	87,-	3,1	3,7
ONS	Zarážka dveří 1004	C10046X00	72,-	87,-	3,1	3,7
OFS	Zarážka dveří 1004	C10048X00	72,-	87,-	3,1	3,7
OLV	Zarážka dveří 1004	C10042X00	72,-	87,-	3,1	3,7

Povrch	typ provedení	obj. číslo	CZK	s DPH	EUR	s DPH
IN	Zarážka dveří 2264	C2264EX00	101,-	122,-	4,3	5,2
OCS	Zarážka dveří 2264	C22649X00	100,-	120,-	4,2	5,1
OC	Zarážka dveří 2264	C22645X00	100,-	120,-	4,2	5,1
ONS	Zarážka dveří 2264	C22646X00	100,-	120,-	4,2	5,1
OFS	Zarážka dveří 2264	C22648X00	100,-	120,-	4,2	5,1
OLV	Zarážka dveří 2264	C22642X00	100,-	120,-	4,2	5,1

Povrch	typ provedení	obj. číslo	CZK	s DPH	EUR	s DPH
IN	Zarážka dveří Ø 25	C1001EX00	100,-	121,-	4,3	5,1
OCS	Zarážka dveří Ø 32	C10019X00	146,-	176,-	6,2	7,4
OC	Zarážka dveří Ø 32	C10015X00	146,-	176,-	6,2	7,4
ONS	Zarážka dveří Ø 32	C10016X00	146,-	176,-	6,2	7,4
OFS	Zarážka dveří Ø 32	C10018X00	146,-	176,-	6,2	7,4
OLV	Zarážka dveří Ø 32	C10012X00	146,-	176,-	6,2	7,4

Povrch	typ provedení	obj. číslo	CZK	s DPH	EUR	s DPH
IN	Zarážka puk	RIZARPUK	278,-	337,-	11,8	14,2

Zarážka okenní

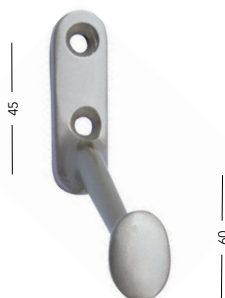

Povrch	typ provedení	obj. číslo	CZK	s DPH	EUR	s DPH
OCS	Okenní zarážka	81990090	170,-	206,-	7,2	8,7
OC	Okenní zarážka	81990050	170,-	206,-	7,2	8,7
ONS	Okenní zarážka	81990060	170,-	206,-	7,2	8,7
OLV	Okenní zarážka	81990010	170,-	206,-	7,2	8,7
OFS	Okenní zarážka	81990030	170,-	206,-	7,2	8,7
BILÁ	Okenní zarážka	81990070	170,-	206,-	7,2	8,7
OV	Okenní zarážka	81990040	170,-	206,-	7,2	8,7

Přídavné řetízky a kukátka

Povrch	typ provedení	obj. číslo	CZK	s DPH	EUR	s DPH
OC	Zástrč 620GA	R620GA5	241,-	291,-	10,2	12,3
OFS	Zástrč 620GA	R620GA7	241,-	291,-	10,2	12,3
OLV	Zástrč 620GA	R620GA2	241,-	291,-	10,2	12,3
OC	Zarážka okenní 603FE	RJ603FE5	278,-	337,-	11,8	14,2
OFS	Zarážka okenní 603FE	RJ603FE7	278,-	337,-	11,8	14,2
OLV	Zarážka okenní 603FE	RJ603FE2	278,-	337,-	11,8	14,2
OC	Řetízek 636CN	RJ636CN5	166,-	201,-	7,1	8,5
OLV	Řetízek 636CN	RJ636CN2	166,-	201,-	7,1	8,5
OC	Řetízek 633CN	RJ633CN5	177,-	214,-	7,5	9,0
OLV	Řetízek 633CN	RJ633CN2	177,-	214,-	7,5	9,0
ONS	Řetízek	CRETO6	144,-	175,-	6,1	7,4
OFS	Řetízek	CRETO8	144,-	175,-	6,1	7,4
OLV	Řetízek	CRETO2	144,-	175,-	6,1	7,4
OC	Kuk 3 14/35-60 mm	A4231	171,-	207,-	7,3	8,7
OCS	Kuk 3 14/35-60 mm	A42316	214,-	259,-	9,1	10,9
OLV	Kuk 3 14/35-60 mm	A1237	182,-	220,-	7,7	9,3
OC	Kuk 5 16/60-85 mm	A4233	278,-	337,-	11,8	14,2
OCS	Kuk 5 16/60-85 mm	A42336	300,-	363,-	12,7	15,3
OLV	Kuk 5 16/60-85 mm	A1482	300,-	363,-	12,7	15,3

Řetízek 636CN



Řetízek



Zástrč 620GA



Zarážka okenní 603FE



Řetízek 633CN



Kukátko



Povrch	typ provedení	obj. číslo	CZK	s DPH	EUR	s DPH
OLV	KUKÁTKO DIGITÁLNÍ PR14/40-70 mm	A21376	2800,-	3388,-	119,1	142,9
OC	KUKÁTKO DIGITÁLNÍ PR14/40-70 mm	A21377	2800,-	3388,-	119,1	142,9



Dveřní sklapka

Povrch	typ provedení	obj. číslo	CZK	s DPH	EUR	s DPH
OLV	Sklapka komplet A	M06042X0A	180,-	218,-	7,7	9,2
OLV	Sklapka komplet B	M06042X0B	180,-	218,-	7,7	9,2



Držák zábradlí

L8757



L8758



C2263 31



M099



Povrch	typ provedení	obj. číslo	CZK	s DPH	EUR	s DPH
IN	L8757	CSL8757	540,-	654,-	23,0	27,6
IN	L8758	CSL8758	653,-	790,-	27,8	33,3
IN	C2263 31	C2263EX31	257,-	311,-	10,9	13,1
OF5	M099	M09908X00	551,-	667,-	23,4	28,1
OLV	M099	M09902X00	551,-	667,-	23,4	28,1

Drobný materiál

Červík



Poj. kroužek



Pružina



Rohatka dvoustr.



Rohatka jednostr.



Vrut



Přechodka



Šroub průchozí



Tyčka



Nový kod	Nový název	CZK	s DPH	EUR	s DPH
SMK0101	Cervik _5mm (2Ks)	15,-	18,-	0,6	0,8
SMK0102	Cervik _6mm (2Ks)	15,-	18,-	0,6	0,8
SMK0103	Cervik D.3mm (2Ks)	15,-	18,-	0,6	0,8
SMK0201	Poj.krouzek D.15	5,-	6,-	0,4	0,5
SMK0301	Prechodka 4/6mm - (Plast)	12,-	14,-	0,5	0,6
SMK0302	Prechodka 6/7mm	18,-	22,-	0,8	0,9
SMK0303	Prechodka 6/8mm	18,-	22,-	0,8	0,9
SMK0304	Prechodka 7/8mm	18,-	22,-	0,8	0,9
SMK0306	Prechodka 8/8.5mm	18,-	22,-	0,8	0,9
SMK0307	Prechodka 8/9mm	18,-	22,-	0,8	0,9
SMK0305	Prechodka 8/10mm	18,-	22,-	0,8	0,9
SMK0401	Pružina silnejsi	5,-	6,-	0,2	0,3
SMK0402	Pružina slabši	5,-	6,-	0,2	0,3
SMK0501	Rohatka dvoustr. 1.2mm	5,-	6,-	0,2	0,3
SMK0502	Rohatka jednostr.1.0mm	5,-	6,-	0,2	0,3
SMK0601	Sroub Pruchozi - rozeta - matka M4	6,-	8,-	0,3	0,3
SMK0602	Sroub Pruchozi - rozeta M4	9,-	10,-	0,4	0,4
SMK0701	Tycka 8X8x70mm se závitem	32,-	39,-	1,3	1,6
SMK0702	Tycka 8X8x78mm se závitem	34,-	41,-	1,4	1,7
SMK0703	Tycka 8X8x95mm	20,-	25,-	0,9	1,0
SMK0704	Tycka 8X8x10mm	20,-	25,-	0,9	1,0
SMK0705	Tycka 8X8x110mm	20,-	25,-	0,9	1,0
SMK0706	Tycka 8X8x140mm	20,-	25,-	0,9	1,0
SMK0707	Tycka 8X8x150mm	20,-	25,-	0,9	1,0
SMK0801	Vrut 3,5X25mm Olv (4Ks)	5,-	6,-	0,2	0,3
SMK0802	Vrut 3,5X25mm Of (4Ks)	5,-	6,-	0,2	0,3
SMK0803	Vrut 3,5X25mm Ocn (4Ks)	5,-	6,-	0,2	0,3
SMKSAD01	Spojovací mat. - štítové kov. Olv	22,-	27,-	1,0	1,1
SMKSAD02	Spojovací mat. - štítové kov. Of	22,-	27,-	1,0	1,1
SMKSAD03	Spojovací mat. - štítové kov. univ.	22,-	27,-	1,0	1,1
SMKSAD04	Spojovací mat. - štítové kov. - nerez	22,-	27,-	1,0	1,1
SMKSAD05	Spojovací mat. - rozetové kování	22,-	27,-	1,0	1,1
SMKSAD06	Spojovací mat. - ozetové kování M3	22,-	27,-	1,0	1,1
SMKSAD07	Spojovací mat. - ozetové kování plast	22,-	27,-	1,0	1,1

Krbové nářadí

Povrch	typ provedení	obj. číslo	CZK	s DPH	EUR	s DPH
černá	Inox	KRBINOX	1110,-	1343,-	47,2	56,7
černá	Rustik	KRBRUSTIK	1110,-	1343,-	47,2	56,7
černá	Wood	KRBWOOD	745,-	901,-	31,7	38,0

Inox



620

Rustik



620

Wood



640

Cobra dětem Kiddy

cena za kus

Povrch	typ provedení	obj. číslo	CZK	s DPH	EUR	s DPH
Červená	BB 72 červená	B222C164	255,-	309,-	10,9	13,0
Žlutá	BB 72 žlutá	B222ZL164	255,-	309,-	10,9	13,0
Zelená	BB 72 zelená	B222Z164	255,-	309,-	10,9	13,0
Modrá	BB 72 modrá	B222M164	255,-	309,-	10,9	13,0

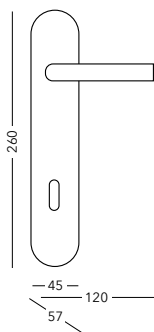

Do vyprodání zásob

Dětský věšák

Do vyprodání zásob



550



cena za kus

Povrch	typ provedení	obj. číslo	CZK	s DPH	EUR	s DPH
Červená	Červený 4 háčky	B223C00	305,-	369,-	13,0	15,6
Žlutá	Žlutý 4 háčky	B223ZL00	305,-	369,-	13,0	15,6
Zelená	Zelený 4 háčky	B223Z00	305,-	369,-	13,0	15,6
Modrá	Modrý 4 háčky	B223M00	305,-	369,-	13,0	15,6

Panikové kování Dorma



PHA 2000

S řadou PHA 2000 a s univerzálně použitelným vnějším kováním PHT máte k dispozici program, který lze využít jak u úzkých systémů profilových dveří, tak také u plných dveří. Systém je modulární, snadno nastavitelný pro různé šířky a výšky dveří. Uzávěr panikových dveří je přezkoušen podle EN 1125.

Exit Pad

Kování řady DORMA Exit Pad jsou vysoce kvalitní uzávěry pro nouzové východy dveří v únikových cestách a lze je kombinovat s komponenty řad PHA 2000. Používají se v budovách bez pohybu veřejnosti. Očekává se, že lidé využívající budovu znají příslušné východy a jejich vybavení, aby v nouzové situaci nedošlo k panice. Produkty Exit Pad jsou přezkoušeny a certifikovány podle EN 179.

Výhody

- Snadná montáž (levé i pravé dveře)
- Jednoduché nastavení pro různé šířky a výšky dveří
- Univerzální použití externího kování s klikou nebo DORMA
- Rozvorové tyče s kovovými kryty
- Jednoduchá obsluha a vynikající kvalita zajišťuje vysokou životnost
- Balení vše v jednom



Jak vybrat komponenty?

Komponenty u jednokřídlých dveří

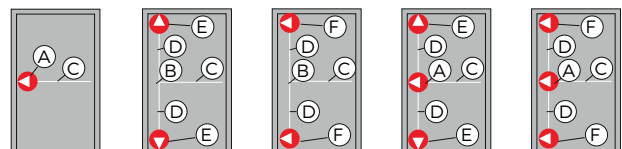

A,C lze nahradit G

B,C lze nahradit H

B,C lze nahradit H

A,C lze nahradit G

D,E lze nahradit F

Komponenty u dvoukřídlých dveří

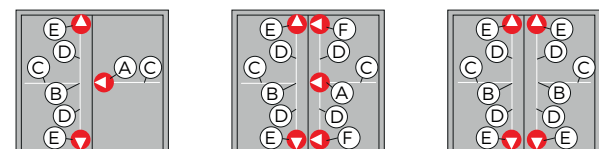

B,C lze nahradit H A,C lze nahradit G

B,C lze nahradit H B,C lze nahradit

	A	B	C	D	E
	PHA 2101 *	PHA 2201	PHA 2104	PHX 04 *	PHX 03
OBJ. KÓD	HBDPHA2101	HBDPHA2201	HBDPHA2104	HBDPHX04	HBDPHX03
CENA	3 190,00	2 655,00	440,00	1 155,00	2 695,00
NÁZEV	1-bodové zamykání	2-bodové zamykání	paniková tyč	sada rozvorových tyčí	horní a dolní zamykání

	F	G	H	CH	I
	PHX 06 *	EXIT PAD *	EXIT PAD 2P *	PHT 01 *	PHT 06 *
OBJ. KÓD	HBDPHX06	HBDEXITPAD	HBDEXITPAD2	HBDPHT01	HBDPHT06
CENA	6 210,00	3 190,00	6 551,00	1 915,00	1 775,00
NÁZEV	horní a dolní zamykání s horizontální střílkou	1-bodové zamykání	2-bodové zamykání	vnější kování s klikou	vnější kování s pevnou koulí

* U JEDNOKŘÍDLÝCH A DVOUKŘÍDLÝCH DVEŘÍ LZE POUŽÍT KOVÁNÍ S KLIKOU (CH) A PEVNOU KOULÍ (I)

Sada PHA 2000 - 1/1 pro jednokřídlé dveře, 1-bodové uzamykání	CZK	s DPH	EUR	s DPH
Panikové kování 1-bodové 2101	3190,-	3860,-	135,7	162,9
Sada PHA 2000 - 1/3 pro jednokřídlé dveře, 3-bodové uzamykání				
Panikové kování 3-bodové 2101	3190,-	3860,-	135,7	162,9
Horní a spodní stříelky černé PHX03	2695,-	3261,-	114,7	137,6
Rozvorové táhla stříbrné PHX04	1155,-	1398,-	49,1	59,0
Sada PHA 2000 - 2/3 pro dvoukřídlé dveře, 3-bodové uzamykání				
Panikové kování 1-bodové 2101	3190,-	3860,-	135,7	162,9
Panikové kování 2-bodové 2201	2655,-	3213,-	113,0	135,6
Horní a spodní stříelky černé PHX03	2695,-	3261,-	114,7	137,6
Rozvorové táhla stříbrné PHX04	1155,-	1398,-	49,1	59,0
Sada PUSHPAD 1/1 pro jednokřídlé dveře, 1-bodové uzamykání				
Panikové kování EXITPAD, 1-bodové	3190,-	3860,-	135,7	162,9
Sada PUSHPAD 1/3 pro jednokřídlé dveře, 3-bodové uzamykání				
Panikové kování EXITPAD, 3-bodové	3190,-	3860,-	135,7	162,9
Horní a spodní stříelky černé	2695,-	3261,-	114,7	137,6
Rozvorové táhla stříbrné	1155,-	1398,-	49,1	59,0
Madla pro panikové kování (nejsou součástí nabídky a je nutno je uvádět zvlášť)				
Ocelové madlo stříbrné, 1000 mm PHA2104	440,-	532,-	18,7	22,5
Vnější kliky k panikovému kování (nejsou součástí nabídky a je nutno je uvádět zvlášť)				
Stříbrný štít pro uzamykatelnou kliku pro cyl. půlvložku PHT01	1915,-	2318,-	81,5	97,8
Stříbrný štít s koulí pro cyl. půlvložku PHT06	1775,-	2148,-	75,5	90,6



Rozety

5 3

Bez otvoru



Ø 55

BB



Ø 52/55

PZ



Ø 52/55

WC



Ø 52/55



Ø 52/55

BB/ PZ ovál



70

— 30 —

BB/PZ hranatý ovál



60

— 30 —



55



55



55

WC set



55



55



Sortiment rozetového kování na masivní základně nabízíme na šroubovacích rozetách.
Sortiment rozetového kování Economy nabízíme na narážecích rozetách pro snadnou a rychlou montáž.

*Záruka 3 roky na povrch OCS, cena za kus (WC cena za pár)

*Záruka 5 roky na povrch IN, cena za kus (WC cena za pár)

	Povrch	typ provedení	CZK	s DPH	EUR	s DPH
🔑	IN	BB/PZ	140,-	169,-	6,0	7,1
🔑	IN	WC set	350,-	424,-	14,9	17,9
🔑	IN	Ovál BB/PZ	140,-	169,-	6,0	7,1
🔑	IN	Ovál WC	350,-	424,-	14,9	17,9
🔑	OCS	BB/PZ	140,-	169,-	6,0	7,1
🔑	OCS	WC set	350,-	424,-	14,9	17,9
🔑	OC	BB/PZ	140,-	169,-	6,0	7,1
🔑	OC	WC set	350,-	424,-	14,9	17,9

	Povrch	typ provedení	CZK	s DPH	EUR	s DPH
🔑	ONS	BB/PZ	140,-	169,-	6,0	7,1
🔑	ONS	WC set	350,-	424,-	14,9	17,9
🔑	OCN	BB/PZ	140,-	169,-	6,0	7,1
🔑	OCN	WC set	350,-	424,-	14,9	17,9
🔑	OF	BB/PZ	140,-	169,-	6,0	7,1
🔑	OF	WC set	350,-	424,-	14,9	17,9
🔑	OLV	BB/PZ	140,-	169,-	6,0	7,1
🔑	OLV	WC set	350,-	424,-	14,9	17,9

	Povrch	typ provedení	CZK	s DPH	EUR	s DPH
🔑	IN	BB/PZ economy	140,-	169,-	6,0	7,1
🔑	IN	WC set economy	350,-	424,-	14,9	17,9
🔑	IN	BB/PZ hr. ovál	140,-	169,-	6,0	7,1
🔑	IN	Bez otvoru hr. ovál	140,-	169,-	6,0	7,1

Vrtací šablona

🔑	CZK	bez DPH	s DPH
	cena	1140,-	1379,-
🔑	EUR	bez DPH	s DPH
	cena	48,5	58,2



šablona na panty

Vrtací šablona na panty

Rozměry	CZK	s DPH	EUR	s DPH
190 (030.055.300) 13 PVC	805,-	974,-	34,3	41,1
190 (030.055.300) 14 PVC	835,-	1010,-	35,5	42,6
320 16 PVC	875,-	1059,-	37,2	44,7
495 14/16 PVC	915,-	1107,-	38,9	46,7
190 (180.030.055.300) 16 PVC	915,-	1107,-	38,9	46,7
320 18 PVC	915,-	1107,-	38,9	46,7
495 20 PVC	950,-	1150,-	40,4	48,5
320 20 PVC	950,-	1150,-	40,4	48,5

Těsnící prahová lišta s gumou nebo kartáčem

Povrch	typ provedení	obj. číslo	CZK	s DPH	EUR	s DPH
Bílá	Guma 1000 mm	PC-1250B	255,-	309,-	10,9	13,0
Hnědá	Guma 1000 mm	PC-1250H	255,-	309,-	10,9	13,0
Bílá	Kartáč 1000 mm	PC-1251B	255,-	309,-	10,9	13,0
Hnědá	Kartáč 1000 mm	PC-1251H	255,-	309,-	10,9	13,0



Mechanická výsuvná prahová lišta

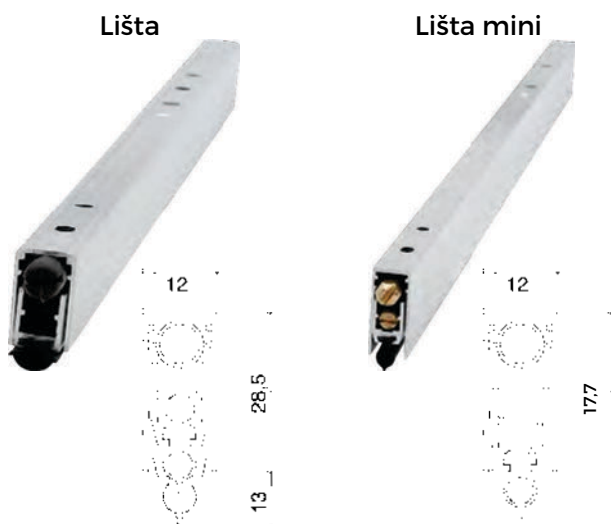

Název	obj. číslo	CZK	s DPH	EUR	s DPH
Lišta mini 330 mm	PC-420M033	365,-	442,-	15,5	18,6
Lišta mini 430 mm	PC-420M043	375,-	453,-	15,9	19,1
Lišta mini 630 mm	PC-420M063	395,-	478,-	16,8	20,2
Lišta mini 830 mm	PC-420M083	435,-	526,-	18,5	22,2
Lišta mini 930 mm	PC-420M093	445,-	538,-	18,9	22,7
Lišta mini 1030 mm	PC-420M103	460,-	557,-	19,6	23,5
Lišta mini 1230 mm	PC-420M123	490,-	593,-	20,9	25,0
Lišta mini 1330 mm	PC-420M133	490,-	593,-	20,9	25,0
Lišta 430 mm	PC-T017043	540,-	654,-	23,0	27,6
Lišta 530 mm	PC-T017053	550,-	666,-	23,4	28,1
Lišta 630 mm	PC-T017063	575,-	696,-	24,5	29,4
Lišta 730 mm	PC-T017073	590,-	714,-	25,1	30,1
Lišta 830 mm	PC-T017083	615,-	744,-	26,2	31,4
Lišta 930 mm	PC-T017093	615,-	744,-	26,2	31,4
Lišta 1030 mm	PC-T017103	645,-	780,-	27,4	32,9
Lišta 1130 mm	PC-T017113	645,-	780,-	27,4	32,9
Lišta 1230 mm	PC-T017123	675,-	817,-	28,7	34,5
Lišta 1330 mm	PC-T017133	700,-	847,-	29,8	35,7

Koordinátor zavírání

Povrch	typ provedení	CZK	s DPH	EUR	s DPH
bílá	Koordinátor zavírání dveří	1820,-	2202,-	77,4	92,9
stříbrná	Koordinátor zavírání dveří	1820,-	2202,-	77,4	92,9

Koordinátor



Pružinový zavírač

Povrch	typ provedení	obj. číslo	CZK	s DPH	EUR	s DPH
Fl	Pružinový zavírač	56-01	890,-	1077,-	37,9	45,4

Pružinový zavírač



Cobra samozavírače

Povrch	typ provedení	CZK	s DPH	EUR	s DPH
stříbrná	RZ 202	550,-	666,-	23,4	28,1
stříbrná	RZ 903	1060,-	1283,-	45,1	54,1

RZ 202 Šířka dveří max 850 mm, váha dveří max 45 kg, síla zavírání č. 2



RZ 903



Dveřní zavírač

GEZE

Od modelu TS1000 použitelné pro požární a kouřotěsné dveře. Modely TS2000 a TS4000 je možno za příplatek dodat s vypínací aretací.

Povrch	typ a síla zavírání	obj. číslo	CZK	s DPH	EUR	s DPH
Bílá	TS1000 2/3	TS1000B	990,-	1198,-	42,1	50,6
Hnědá	TS1000 2/3	TS1000H	990,-	1198,-	42,1	50,6
Stříbrná	TS1000 2/3	TS1000S	990,-	1198,-	42,1	50,6
Bílá	TS1000 + aretace	TS1000BAN	1825,-	2208,-	77,7	93,2
Hnědá	TS1000 + aretace	TS1000HAN	1825,-	2208,-	77,7	93,2
Stříbrná	TS1000 + aretace	TS1000SAN	1825,-	2208,-	77,7	93,2
Bílá	TS1500 3/4	TS1500B	1625,-	1966,-	69,1	83,0
Hnědá	TS1500 3/4	TS1500H	1625,-	1966,-	69,1	83,0
Stříbrná	TS1500 3/4	TS1500S	1518,-	1837,-	69,1	83,0
Bílá	TS1500 + aretace	TS1500BAN	2210,-	2674,-	94,0	112,9
Hnědá	TS1500 + aretace	TS1500HAN	2210,-	2674,-	94,0	112,9
Stříbrná	TS1500 + aretace	TS1500SAN	2210,-	2674,-	94,0	112,9
Bílá	TS2000 2/4/5	TS2000B	1390,-	1682,-	59,1	71,0
Hnědá	TS2000 2/4/5	TS2000H	1390,-	1682,-	59,1	71,0
Stříbrná	TS2000 2/4/5	TS2000S	1390,-	1682,-	59,1	71,0
Bílá	TS2000 + aretace	TS2000BAN	2700,-	3267,-	114,9	137,9
Hnědá	TS2000 + aretace	TS2000HAN	2700,-	3267,-	114,9	137,9
Stříbrná	TS2000 + aretace	TS2000SAN	2700,-	3267,-	114,9	137,9
Bílá	TS3000 1-4	TS3000B	3845,-	4652,-	163,6	196,3
Hnědá	TS3000 1-4	TS3000H	3845,-	4652,-	163,6	196,3
Stříbrná	TS3000 1-4	TS3000S	3845,-	4652,-	163,6	196,3
Bílá	TS3000 + aretace	TS3000BAN	4740,-	5735,-	201,7	242,0
Hnědá	TS3000 + aretace	TS3000HAN	4740,-	5735,-	201,7	242,0
Stříbrná	TS3000 + aretace	TS3000SAN	4740,-	5735,-	201,7	242,0
Bílá	TS4000 1-6/5-7	TS4000B	3375,-	4084,-	143,6	172,3
Hnědá	TS4000 1-6/5-7	TS4000H	3375,-	4084,-	143,6	172,3
Stříbrná	TS4000 1-6/5-7	TS4000S	3375,-	4084,-	143,6	172,3
Bílá	TS4000 + aretace	TS4000BAN	4360,-	5276,-	185,5	222,6
Hnědá	TS4000 + aretace	TS4000HAN	4360,-	5276,-	185,5	222,6
Stříbrná	TS4000 + aretace	TS4000SAN	4360,-	5276,-	185,5	222,6
Bílá	TS5000 5-6	TS5000B	6615,-	8004,-	281,5	337,8
Hnědá	TS5000 5-6	TS5000H	6615,-	8004,-	281,5	337,8
Stříbrná	TS5000 5-6	TS5000S	6615,-	8004,-	281,5	337,8
Bílá	TS5000 + aretace	TS5000BAN	7465,-	9033,-	317,7	381,2
Hnědá	TS5000 + aretace	TS5000HAN	7465,-	9033,-	317,7	381,2
Stříbrná	TS5000 + aretace	TS5000SAN	7465,-	9033,-	317,7	381,2

Samozavírač DC 120 / DC 140 / DC 300 stříbrný

Povrch	typ provedení	CZK	s DPH	EUR	s DPH
stříbrná	Samozavírač DC 120	1370,-	1657,-	58,3	69,9
stříbrná	Samozavírač DC 140	1540,-	1863,-	65,5	78,6

DC 120



Šířka dveří max 1100 mm,
váha dveří max 80 kg,
síla zavírání č. 2, 3, 4

DC 140



Šířka dveří max 1250 mm,
váha dveří max 80 kg,
síla zavírání č. 2, 3, 4

Povrch	typ provedení	CZK	s DPH	EUR	s DPH
stříbrná	Samozavírač DC 300 s ramínkem	3315,-	4011,-	141,1	169,3
stříbrná	Samozavírač DC 300 s aretačním ramínkem	3850,-	4659,-	163,8	196,6
stříbrná	Samozavírač DC 300 s kluznou lištou	3400,-	4114,-	144,7	173,6

DC 300



Větrací mřížky

Povrch	typ provedení	obj. číslo	CZK	s DPH	EUR	s DPH
Bílá	60x400 mm	CM0600400B	90,-	109,-	3,8	4,6
Hnědá	60x400 mm	CM0600400H	90,-	109,-	3,8	4,6
Stříbrná	60x400 mm	CM0600400S	90,-	109,-	3,8	4,6
Bílá	60x500 mm	CM0600500B	105,-	127,-	4,5	5,4
Hnědá	60x500 mm	CM0600500H	105,-	127,-	4,5	5,4
Stříbrná	60x500 mm	CM0600500S	105,-	127,-	4,5	5,4
Bílá	60x600 mm	CM0600600B	130,-	157,-	5,5	6,6
Hnědá	60x600 mm	CM0600600H	130,-	157,-	5,5	6,6
Stříbrná	60x600 mm	CM0600600S	130,-	157,-	5,5	6,6
Bílá	60x800 mm	CM0600800B	170,-	206,-	7,2	8,7
Hnědá	60x800 mm	CM0600800H	170,-	206,-	7,2	8,7
Stříbrná	60x800 mm	CM0600800S	170,-	206,-	7,2	8,7
Bílá	60x1000 mm	CM0601000B	195,-	236,-	8,3	9,9
Hnědá	60x1000 mm	CM0601000H	195,-	236,-	8,3	9,9
Stříbrná	60x1000 mm	CM0601000S	195,-	236,-	8,3	9,9
Bílá	80x400 mm	CM0800400B	105,-	127,-	4,5	5,4
Hnědá	80x400 mm	CM0800400H	105,-	127,-	4,5	5,4
Stříbrná	80x400 mm	CM0800400S	105,-	127,-	4,5	5,4
Bílá	80x500 mm	CM0800500B	140,-	169,-	6,0	7,1
Hnědá	80x500 mm	CM0800500H	140,-	169,-	6,0	7,1
Stříbrná	80x500 mm	CM0800500S	140,-	169,-	6,0	7,1
Bílá	80x600 mm	CM0800600B	165,-	200,-	7,0	8,4
Hnědá	80x600 mm	CM0800600H	165,-	200,-	7,0	8,4
Stříbrná	80x600 mm	CM0800600S	165,-	200,-	7,0	8,4
Bílá	80x800 mm	CM0800800B	165,-	200,-	8,7	10,5
Hnědá	80x800 mm	CM0800800H	205,-	249,-	8,7	10,5
Stříbrná	80x800 mm	CM0800800S	205,-	249,-	8,7	10,5
Bílá	80x1000 mm	CM0801000B	205,-	249,-	11,3	13,5
Hnědá	80x1000 mm	CM0801000H	265,-	321,-	11,3	13,5
Stříbrná	80x1000 mm	CM0801000S	265,-	321,-	11,3	13,5
Bílá	100x400 mm	CM1000400B	125,-	151,-	5,3	6,4
Hnědá	100x400 mm	CM1000400H	125,-	151,-	5,3	6,4
Stříbrná	100x400 mm	CM1000400S	125,-	151,-	5,3	6,4
Bílá	100x500 mm	CM1000500B	170,-	206,-	7,2	8,7
Hnědá	100x500 mm	CM1000500H	170,-	206,-	7,2	8,7
Stříbrná	100x500 mm	CM1000500S	170,-	206,-	7,2	8,7
Bílá	100x600 mm	CM1000600B	210,-	254,-	8,9	10,7
Hnědá	100x600 mm	CM1000600H	210,-	254,-	8,9	10,7
Stříbrná	100x600 mm	CM1000600S	210,-	254,-	8,9	10,7
Bílá	100x800 mm	CM1000800B	265,-	321,-	11,3	13,5
Hnědá	100x800 mm	CM1000800H	265,-	321,-	11,3	13,5
Stříbrná	100x800 mm	CM1000800S	265,-	321,-	11,3	13,5
Bílá	100x1000 mm	CM1001000B	320,-	387,-	13,6	16,3
Hnědá	100x1000 mm	CM1001000H	320,-	387,-	13,6	16,3
Stříbrná	100x1000 mm	CM1001000S	320,-	387,-	13,6	16,3

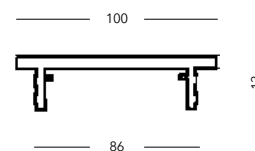
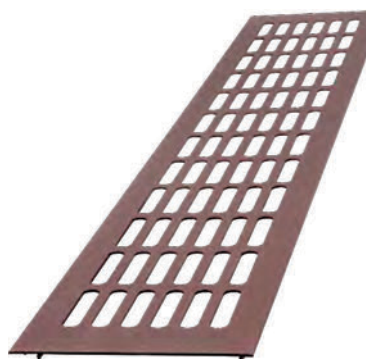
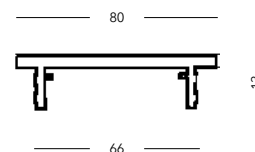

Vhozy na dopisy

Povrch	typ provedení	obj. číslo	CZK	s DPH	EUR	s DPH
ONS	Vittoria 255x74 mm	FB0255766	877,-	1061,-	37,3	44,8
OFS	Vittoria 255x74 mm	FB0255768	877,-	1061,-	37,3	44,8
OLV	Vittoria 255x74 mm	FB0255762	711,-	860,-	30,2	36,2
K	Bernard 285x85 mm	HA121009	980,-	1186,-	41,7	50,0
K	Rustikal 285x85 mm	HA121007	980,-	1186,-	41,7	50,0

Vittoria



Bernard



Rustikal



Věšáky kované

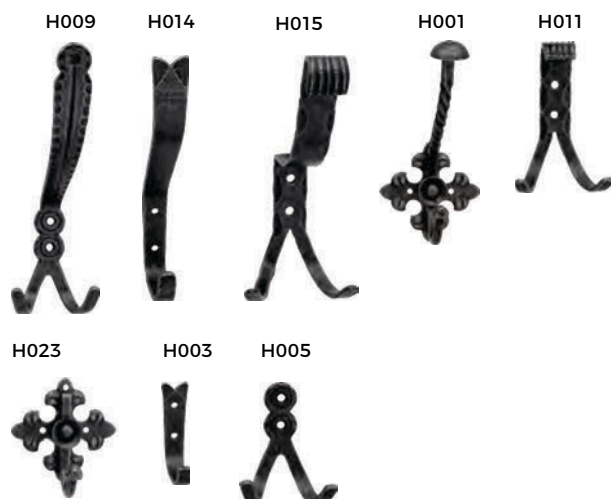









Povrch	typ provedení	obj. číslo	CZK	s DPH	EUR	s DPH
K	H001 80x160 mm	HAH001	412,-	498,-	17,5	21,0
K	H003 60 mm	HAH003	107,-	129,-	4,6	5,5
K	H005 70x90 mm	HAH005	203,-	246,-	8,7	10,4
K	H009 70x210 mm	HAH009	230,-	278,-	9,8	11,7
K	H011 65x105 mm	HAH011	182,-	220,-	7,7	9,3
K	H014 170 mm	HAH014	134,-	162,-	5,7	6,8
K	H015 70x170 mm	HAH015	230,-	278,-	9,8	11,7
K	H023 80x85 mm	HAH023	268,-	324,-	11,4	13,7

Věšák



Povrch	typ provedení	obj. číslo	CZK	s DPH	EUR	s DPH
OCS	Věšák 2117	C2117CX90	144,-	175,-	6,1	7,4
ONS	Věšák 2117	C2117CX40	144,-	175,-	6,1	7,4
OLV	Věšák 2117	C2117CX20	144,-	175,-	6,1	7,4
BÍLÁ	Věšák 2117	C2117CX60	144,-	175,-	6,1	7,4
OCS	Věšák 2105	C2105CX90	145,-	175,-	6,2	7,4
OC	Věšák 2105	C2105CX10	145,-	175,-	6,2	7,4
ONS	Věšák 2105	C2105CX40	145,-	175,-	6,2	7,4
OFS	Věšák 2105	C2105CX30	145,-	175,-	6,2	7,4
OLV	Věšák 2105	C2105CX20	145,-	175,-	6,2	7,4
černá	Věšák 2105	C2105CX50	85,-	102,-	3,6	4,3
BÍLÁ	Věšák 2105	C2105CX60	145,-	175,-	6,2	7,4
OCS	Věšák 2120	C2120CX90	105,-	127,-	4,5	5,4
OC	Věšák 2120	C2120CX10	105,-	127,-	4,5	5,4
ONS	Věšák 2120	C2120CX40	105,-	127,-	4,5	5,4
OFS	Věšák 2120	C2120CX30	105,-	127,-	4,5	5,4
OLV	Věšák 2120	C2120CX20	105,-	127,-	4,5	5,4
černá	Věšák 2120	C2120CX50	75,-	91,-	3,2	3,8
BÍLÁ	Věšák 2120	C2120CX60	105,-	127,-	4,5	5,4
OCS	Věšák 2217	C2217CX90	67,-	81,-	2,8	3,4
OC	Věšák 2217	C2217CX10	67,-	81,-	2,8	3,4
ONS	Věšák 2217	C2217CX40	67,-	81,-	2,8	3,4
OCS	Věšák 2216	C2216CX90	109,-	132,-	4,6	5,6
OC	Věšák 2216	C2216CX10	109,-	132,-	4,6	5,6
ONS	Věšák 2216	C2216CX40	109,-	132,-	4,6	5,6
OFS	Věšák 2216	C2216CX30	109,-	132,-	4,6	5,6
OLV	Věšák 2216	C2216CX20	109,-	132,-	4,6	5,6
OCS	Věšák 2108	C2108CX90	43,-	52,-	1,8	2,1
OC	Věšák 2108	C2108CX10	42,-	50,-	1,8	2,2
ONS	Věšák 2108	C2108CX40	42,-	50,-	1,8	2,1
OLV	Věšák 2108	C2108CX20	42,-	50,-	1,8	2,1
černá	Věšák 2108	C2108CX50	22,-	27,-	1,0	1,1
BÍLÁ	Věšák 2108	C2108CX60	42,-	50,-	1,8	2,1

Háčky

				Povrch	typ provedení	obj. číslo	CZK	s DPH	EUR	s DPH
C001	C002	C005	C007	OFS	Háček C001	C001	50,-	61,-	2,1	2,6
				K	Háček C002	C002	33,-	40,-	1,4	1,7
140	140	155	160	OFS	Háček C003	C003	24,-	28,-	1,0	1,2
60	60	60	55	K	Háček C004	C004	26,-	31,-	1,1	1,3
C003	C004	C006	C008	OFS	Háček C005	C005	55,-	66,-	2,3	2,8
				OFS	Háček C006	C006	22,-	27,-	1,0	1,1
70	70	70	65	OFS	Háček C007	C007	55,-	66,-	2,3	2,8
65	65	65	65	OFS	Háček C008	C008	21,-	26,-	0,9	1,1

Držák na květináč

Povrch	typ provedení	obj. číslo	CZK	s DPH	EUR	s DPH
K	Držák 170 mm	HA23301	423,-	511,-	18,0	21,6
K	Držák 210 mm	HA23302	444,-	537,-	18,9	22,7



Petlice na dveře

Povrch	typ provedení	obj. číslo	CZK	s DPH	EUR	s DPH
K	Petlice 200x65 mm	HA117003	1165,-	1410,-	49,6	59,5



Zadlabací zámky

Na posuvné dveře

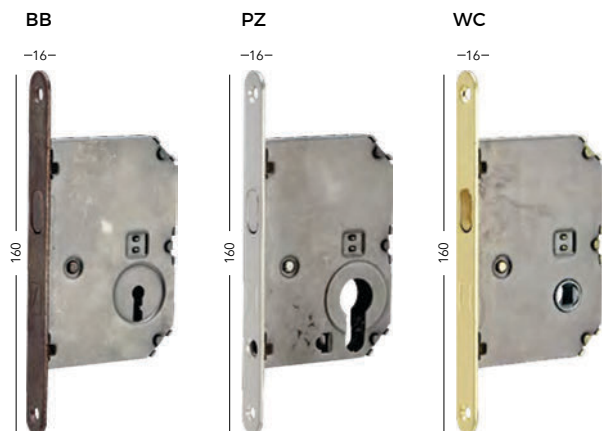

	Povrch	typ provedení	obj. číslo	CZK	s DPH	EUR	s DPH
🔑	OC	BB 60/160	BT16009X10A	440,-	532,-	18,7	22,5
	OC	BB 70/160	BT16009X10B	440,-	532,-	18,7	22,5
	OC	BB 60/160	BT16005X10A	440,-	532,-	18,7	22,5
	OC	BB 70/160	BT16005X10B	440,-	532,-	18,7	22,5
	ONS	BB 60/160	BT16006X10A	415,-	502,-	17,7	21,2
	ONS	BB 70/160	BT16006X10B	415,-	502,-	17,7	21,2
	OF	BB 60/160	BT16007X10A	415,-	502,-	17,7	21,2
	OF	BB 70/160	BT16007X10B	415,-	502,-	17,7	21,2
	OLV	BB 60/160	BT16001X10A	440,-	532,-	18,7	22,5
	OLV	BB 70/160	BT16001X10B	440,-	532,-	18,7	22,5
🔑	OC	PZ 50/160	BT16209X20A	440,-	532,-	18,7	22,5
	OC	PZ 70/160	BT16209X20B	440,-	532,-	18,7	22,5
	OC	PZ 50/160	BT16205X20B	440,-	532,-	18,7	22,5
	OC	PZ 70/160	BT16205X20A	440,-	532,-	18,7	22,5
	ONS	PZ 70/160	BT16206X20B	415,-	502,-	17,7	21,2
	OF	PZ 70/160	BT16207X20B	415,-	502,-	17,7	21,2
	OLV	PZ 50/160	BT16201X20A	440,-	532,-	18,7	22,5
	OLV	PZ 70/160	BT16201X20B	440,-	532,-	18,7	22,5
	OC	WC 60/160	BT16109X30A	440,-	532,-	18,7	22,5
	OC	WC 70/160	BT16109X30B	440,-	532,-	18,7	22,5
🔑	OC	WC 60/160	BT16105X30A	440,-	532,-	18,7	22,5
	OC	WC 70/160	BT16105X30B	440,-	532,-	18,7	22,5
	ONS	WC 60/160	BT16106X30A	415,-	502,-	17,7	21,2
	ONS	WC 70/160	BT16106X30B	415,-	502,-	17,7	21,2
	OF	WC 60/160	BT16107X30A	415,-	502,-	17,7	21,2
	OF	WC 70/160	BT16107X30B	415,-	502,-	17,7	21,2
	OLV	WC 60/160	BT16101X30A	440,-	532,-	18,7	22,5
	OLV	WC 70/160	BT16101X30B	440,-	532,-	18,7	22,5

Interiérové

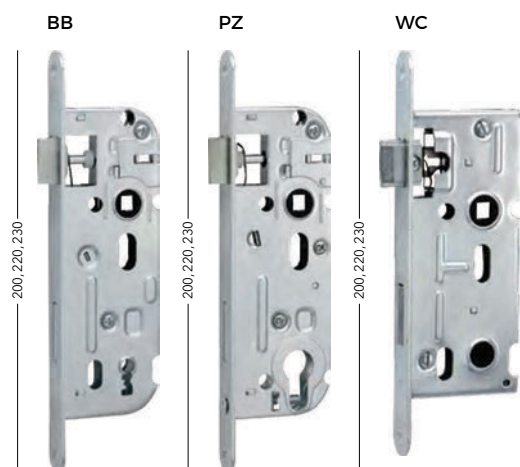

	Povrch	typ provedení	obj. číslo	CZK	s DPH	EUR	s DPH
🔑	POZINK	BB 72/60/200	21120740	220,-	266,-	9,4	11,2
	POZINK	BB 72/80/220	21120640	280,-	339,-	11,9	14,3
	POZINK	BB 90/60/230	21120840	220,-	266,-	9,4	11,2
	POZINK	BB 90/80/230	21120540	230,-	278,-	9,8	11,7
🔑	POZINK	PZ 72/60/200	21120750	230,-	278,-	9,8	11,7
	POZINK	PZ 72/80/220	21120650	290,-	351,-	12,3	14,8
	POZINK	PZ 90/60/230	21120850	230,-	278,-	9,8	11,7
	POZINK	PZ 90/80/230	21120550	220,-	266,-	9,4	11,2
🔑	POZINK	WC 72/60/200	21120760	255,-	309,-	10,9	13,0
	POZINK	WC 72/80/220	21120660	270,-	327,-	11,5	13,8
	POZINK	WC 90/60/230	21120860	290,-	351,-	12,3	14,8
	POZINK	WC 90/80/230	21120560	325,-	393,-	13,8	16,6

Protiplech



Protiplech

Povrch	typ provedení	obj. číslo	CZK	s DPH	EUR	s DPH
POZINK	Protiplech + kapsy	CZP0016P	27,-	32,-	1,1	1,4
ŽL. POZ.	Protiplech + kapsy	CZP0012P	27,-	32,-	1,1	1,4

Interiérové panty

Závěs 030



Povrch	typ provedení	obj. číslo	CZK s DPH	EUR s DPH
POMOS	Závěs 030 13 mm horní	CF030130O006	6,- 8,-	0,3 0,3
POMOS	Závěs 030 13 mm spodní	CG030130O004	9,- 10,-	0,4 0,4
ŽL. POZ	Závěs 030 13 mm horní	CF030130H128	5,- 6,-	0,2 0,3
ŽL. POZ	Závěs 030 13 mm spodní	CG030130H126	6,- 8,-	0,3 0,3
POZINK	Závěs 030 13 mm horní	CF030130H021	5,- 6,-	0,2 0,3
POZINK	Závěs 030 13 mm spodní	CG030130H023	6,- 8,-	0,3 0,3

Povrch	typ provedení	obj. číslo	CZK s DPH	EUR s DPH
ŽL. POZ	Závěs 030 14 mm horní	CF030140H116	5,- 6,-	0,2 0,3
ŽL. POZ	Závěs 030 14 mm spodní	CG030140H118	6,- 8,-	0,3 0,3
ŽL. POZ	Závěs 030 16 mm horní	CF030160H151	7,- 9,-	0,3 0,4
ŽL. POZ	Závěs 030 16 mm spodní	CG030160H161	10,- 12,-	0,4 0,5

Závěs 055



Povrch	typ provedení	obj. číslo	CZK s DPH	EUR s DPH
POMOS	Závěs 055 13 mm horní	CF055130O008	7,- 9,-	0,3 0,4
POMOS	Závěs 055 13 mm spodní	CG055130O010	9,- 10,-	0,4 0,4
ŽL. POZ	Závěs 055 13 mm horní	CF055130H131	5,- 6,-	0,2 0,3
CG055130H131	Závěs 055 13 mm spodní	CG055130H131	6,- 8,-	0,3 0,3
POBR	Závěs 055 13 mm horní	CF055130BN12	6,- 8,-	0,3 0,3
POBR	Závěs 055 13 mm spodní	CG055130BN12	7,- 9,-	0,3 0,4
ONS	Závěs 055 13 mm horní	CF055130N402	20,- 25,-	0,9 1,0
ONS	Závěs 055 13 mm spodní	CG055130N402	22,- 27,-	1,0 1,1
PONIKL	Závěs 055 13 mm horní	CF055130N005	7,- 9,-	0,3 0,4
PONIKL	Závěs 055 13 mm spodní	CG055130N005	10,- 12,-	0,4 0,5
POMOS	Závěs 055 14 mm horní	CF055140O007	7,- 9,-	0,3 0,4
POMOS	Závěs 055 14 mm spodní	CG055140O005	10,- 12,-	0,4 0,5
ŽL. POZ	Závěs 055 14 mm horní	CF055140H119	5,- 6,-	0,2 0,3
POMOS	Závěs 055 14 mm spodní	CG055140O004	32,- 39,-	1,4 1,6

Povrch	typ provedení	obj. číslo	CZK s DPH	EUR s DPH
ŽL. POZ	Závěs 055 14 mm spodní	CG055140H127	7,- 9,-	0,3 0,4
POBR	Závěs 055 14 mm horní	CF055140BN11	7,- 9,-	0,3 0,4
POBR	Závěs 055 14 mm spodní	CG055140BN11	10,- 12,-	0,4 0,5
PONIKL	Závěs 055 14 mm horní	CF055140N004	10,- 12,-	0,4 0,5
PONIKL	Závěs 055 14 mm spodní	CG055140N008	10,- 12,-	0,4 0,5
POMOS	Závěs 055 16 mm horní	CF055160O004	12,- 14,-	0,5 0,6
POMOS	Závěs 055 16 mm spodní	CG055160O004	15,- 18,-	0,6 0,8
ŽL. POZ	Závěs 055 16 mm horní	CF055160H104	10,- 12,-	0,4 0,5
ŽL. POZ	Závěs 055 16 mm spodní	CG055160H106	11,- 13,-	0,5 0,5
POBR	Závěs 055 16 mm horní	CF055160BN04	11,- 13,-	0,5 0,5
POBR	Závěs 055 16 mm spodní	CG055160BN04	16,- 19,-	0,7 0,8
PONIKL	Závěs 055 16 mm horní	CF055160N006	12,- 14,-	0,5 0,6
PONIKL	Závěs 055 16 mm spodní	CG055160N006	15,- 18,-	0,6 0,8

Závěs 100 / 101



Povrch	typ provedení	obj. číslo	CZK s DPH	EUR s DPH
POMOS	Závěs 100 15 mm horní	CF100150O004	15,- 18,-	0,6 0,8
POMOS	Závěs 100 15 mm spodní	CG100150O013	17,- 21,-	0,7 0,9
BRONZ	Závěs 100 15 mm horní	CF100150B105	64,- 78,-	2,7 3,3
BRONZ	Závěs 100 15 mm spodní	CG100150B116	64,- 78,-	2,7 3,3
PONIKL	Závěs 100 15 mm horní	CF100150N007	15,- 18,-	0,6 0,8
PONIKL	Závěs 100 15 mm spodní	CG100150N026	19,- 23,-	0,8 1,0
POZINK	Závěs 100 15 mm horní	CF100150H004	11,- 13,-	0,4 0,5
POZINK	Závěs 100 15 mm spodní	CG100150H017	15,- 18,-	0,6 0,7
ONS	Závěs 100 15 mm horní	CF100150N402	32,- 39,-	1,4 1,6
ONS	Závěs 100 15 mm spodní	CG100150N406	54,- 65,-	2,3 2,7
ONS	Závěs 101 15 mm spodní	CG101150N406	54,- 65,-	2,3 2,7

Závěs 180



Povrch	typ provedení	obj. číslo	CZK	s DPH	EUR	s DPH
POMOS	Závěs 180 16 mm horní	CF180160O004	28,-	34,-	1,2	1,4
POMOS	Závěs 180 16 mm spodní	CG180160O004	30,-	36,-	1,3	1,5
BRONZ	Závěs 180 16 mm horní	CF180160B104	34,-	41,-	1,5	1,7
BRONZ	Závěs 180 16 mm spodní	CG180160B106	37,-	45,-	1,6	1,9

Závěs 190



Povrch	typ provedení	obj. číslo	CZK	s DPH	EUR	s DPH
POMOS	Závěs 190 13 mm horní	CF190130O006	11,-	13,-	0,5	0,5
POMOS	Závěs 190 13 mm spodní	CG190130O006	12,-	14,-	0,5	0,6
ŽL. POZ	Závěs 190 13 mm horní	CF190130H106	10,-	12,-	0,4	0,5
ŽL. POZ	Závěs 190 13 mm spodní	CG190130H108	11,-	13,-	0,5	0,5
POBR	Závěs 190 13 mm horní	CF190130BN06	11,-	13,-	0,5	0,6
POBR	Závěs 190 13 mm spodní	CG190130BN06	11,-	13,-	0,5	0,7
BRONZ	Závěs 190 13 mm horní	CF190130B110	12,-	14,-	0,5	0,6
BRONZ	Závěs 190 13 mm spodní	CG190130B112	14,-	17,-	0,6	0,7
POMOS	Závěs 190 14 mm horní	CF190140O004	11,-	13,-	0,5	0,5
POMOS	Závěs 190 14 mm spodní	CG190140O004	12,-	14,-	0,5	0,6
ŽL. POZ	Závěs 190 14 mm horní	CF190140H104	13,-	16,-	0,5	0,7

Povrch	typ provedení	obj. číslo	CZK	s DPH	EUR	s DPH
ŽL. POZ	Závěs 190 14 mm spodní	CG190140H104	14,-	17,-	0,6	0,7
POBR	Závěs 190 14 mm horní	CF190160BN04	12,-	14,-	0,5	0,6
POBR	Závěs 190 14 mm spodní	CG190140BN04	13,-	16,-	0,5	0,7
POMOS	Závěs 190 16 mm horní	CF190160O002	17,-	21,-	0,7	0,9
POMOS	Závěs 190 16 mm spodní	CG190160O002	18,-	22,-	0,8	0,9
ŽL. POZ	Závěs 190 16 mm horní	CF190160H102	17,-	21,-	0,7	0,9
ŽL. POZ	Závěs 190 16 mm spodní	CG190160H102	16,-	19,-	0,7	0,8
POBR	Závěs 190 16 mm horní	CF190160BN04	17,-	21,-	0,7	0,9
POBR	Závěs 190 16 mm spodní	CG190160BN04	19,-	23,-	0,8	1,0
BRONZ	Závěs 190 16 mm horní	CF190160BN04	17,-	21,-	0,7	0,9
BRONZ	Závěs 190 16 mm spodní	CG190160BN04	19,-	23,-	0,8	1,0

Závěs 221

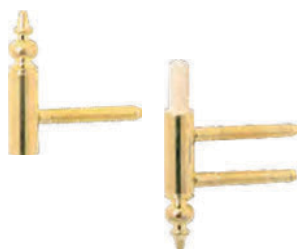

Povrch	typ provedení	obj. číslo	CZK	s DPH	EUR	s DPH
POMOS	Závěs 221 15 mm horní	CF2211500O002	47,-	57,-	2,0	2,4
POMOS	Závěs 221 15 mm spodní	CG2211500O003	54,-	65,-	2,3	2,7
BRONZ	Závěs 221 15 mm horní	CF2211500B102	49,-	60,-	2,1	2,5
BRONZ	Závěs 221 15 mm spodní	CG2211500B105	67,-	82,-	2,9	3,4

Závěs 300



Povrch	typ provedení	obj. číslo	CZK	s DPH	EUR	s DPH
ŽL. POZ	Závěs 300 13 mm	CI300130H110	22,-	27,-	1,0	1,1
POBR	Závěs 300 14 mm	CI300140BN04	30,-	36,-	1,3	1,5
ŽL. POZ	Závěs 300 14 mm	CI300140H112	28,-	34,-	1,2	1,4
POBR	Závěs 300 16 mm	CI300160H104	34,-	41,-	1,5	1,7

Závěs 320



Povrch	typ provedení	obj. číslo	CZK	s DPH	EUR	s DPH
POMOS	Závěs 320 16 mm	CI320160O006	61,-	74,-	2,6	3,1
ŽL.POZ	Závěs 320 16 mm	CI320160H114	43,-	52,-	1,8	2,2
POBR	Závěs 320 16 mm	CI320160BN04	54,-	65,-	2,3	2,7
POMOS	Závěs 320 18 mm	CI320180O006	67,-	82,-	2,9	3,4
ŽL.POZ	Závěs 320 18 mm	CI320180H104	59,-	71,-	2,5	3,0
POBR	Závěs 320 18 mm	CI320180B004	65,-	79,-	2,8	3,3
POMOS	Závěs 320 20 mm	CI320200O008	93,-	113,-	4,0	4,8
ŽL.POZ	Závěs 320 20 mm	CI320200H114	80,-	97,-	3,4	4,1
ŽL.POZ	Závěs 320 20 mm WAS	CI320200H115	120,-	145,-	5,1	6,1
POBR	Závěs 320 20 mm	CI320200BN08	88,-	106,-	3,7	4,5

Závěs 330

Povrch	typ provedení	obj. číslo	CZK	s DPH	EUR	s DPH
POMOS	Závěs 330 16 mm	CI330160O008	134,-	162,-	5,7	6,8
POBR	Závěs 330 16 mm	CI330160B106	134,-	162,-	5,7	6,8



Závěs 488

Povrch	typ provedení	obj. číslo	CZK	s DPH	EUR	s DPH
ŽL.POZ	Závěs 488 16 mm pravý	CI488160H104	456,-	552,-	19,4	23,3
ŽL.POZ	Závěs 488 16 mm levý	CI488160H106	456,-	552,-	19,4	23,3
POZINK	Závěs 488 16 mm pravý	CI488160H504	456,-	552,-	19,4	23,3
POZINK	Závěs 488 16 mm levý	CI488160H506	456,-	552,-	19,4	23,3

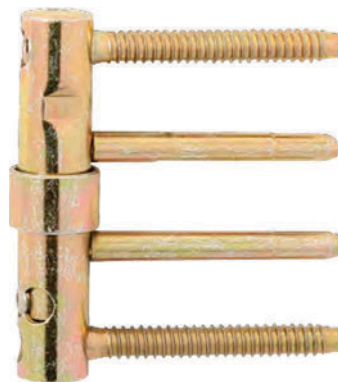

Závěs 495



Povrch	typ provedení	obj. číslo	CZK	s DPH	EUR	s DPH
ŽL.POZ	Závěs 495 14 mm horní	CF495140H119	66,-	80,-	2,8	3,4
ŽL.POZ	Závěs 495 14 mm spodní	CG495140H102	64,-	78,-	2,7	3,3
POZINK	Závěs 495 14 mm horní	CF495140H519	43,-	52,-	1,8	2,2
POZINK	Závěs 495 14 mm spodní	CG495140H502	70,-	84,-	3,0	3,6
ŽL.POZ	Závěs 495 16 mm horní	CF495160H102	56,-	67,-	2,4	2,8
ŽL.POZ	Závěs 495 16 mm spodní	CG495160H102	63,-	76,-	2,7	3,2
POZINK	Závěs 495 16 mm horní	CF495160H502	59,-	71,-	2,5	3,0

Povrch	typ provedení	obj. číslo	CZK	s DPH	EUR	s DPH
POZINK	Závěs 495 16 mm spodní	CG495160H502	87,-	105,-	3,7	4,4
POZINK	Závěs 495 16 mm sp. WAS	CF495160H504	119,-	144,-	5,1	6,1
ŽL.POZ	Závěs 495 20 mm horní	CG495160H504	94,-	114,-	4,0	4,8
ŽL.POZ	Závěs 495 20 mm spodní	CG495200H106	112,-	136,-	4,8	5,7
ŽL.POZ	Závěs 495 20 mm sp. WAS	CF495200H111	171,-	207,-	7,3	8,7
POZINK	Závěs 495 20 mm horní	CF495200H502	92,-	111,-	3,9	4,7
POZINK	Závěs 495 20 mm spodní	CG495200H502	112,-	136,-	4,8	5,7
POZINK	Závěs 495 20 mm sp. WAS	CF495200H505	171,-	207,-	7,3	8,7

Skrytý pant

do 35 kg



do 50 kg



Povrch	typ provedení	obj. číslo	CZK	s DPH	EUR	s DPH
ONS	Nastavitelný do 50 kg	IN300120VN02	770,-	932,-	32,8	39,3
PONIKL	Nastavitelný do 50 kg	IN300120H004	685,-	829,-	29,1	35,0
POZINK	Nastavitelný do 50 kg	IN300120V702	770,-	932,-	32,8	39,3
POBR	Nastavitelný do 50 kg	IN300120BO02	805,-	974,-	34,3	41,1
BÍLÁ	Nastavitelný do 50 kg	IN3001209P02	770,-	932,-	30,2	36,3
ONS	Pevný do 35 kg	IN301090V702	380,-	460,-	16,2	19,4
POBR	Pevný do 35 kg	IN301090BO02	405,-	490,-	17,2	20,7
ONS	Krytka skrytý pant 1 ks	GC300010J205	37,-	45,-	1,6	1,9
POZINK	Krytka skrytý pant 1 ks	GC300010J102	37,-	45,-	1,6	1,9
POBR	Krytka skrytý pant 1 ks	GC3000109R02	37,-	45,-	1,6	1,9
BÍLÁ	Závěs 605 11 mm spodní	CG605110B107	37,-	45,-	1,6	1,9

Návlek k závěsu 495



Povrch	typ provedení	obj. číslo	CZK s DPH	EUR s DPH
OLV	Krytka Ø 16 mm	GC838160L103	86,- 104,-	3,6 4,4
OLV	Krytka Ø 18 mm	GC838180L104	92,- 111,-	3,9 4,7
OLV	Krytka Ø 22 mm	GC838220L104	182,- 220,-	7,7 9,3
POBR	Krytka Ø 16 mm	GC838160B003	59,- 71,-	2,5 3,0
ONS	Krytka Ø 16 mm hranatá	GC901160M702	70,- 85,-	3,0 3,6
ZLATÁ	Krytka Ø 16 mm hranatá	GC901160MK02	70,- 85,-	3,0 3,6
POBR	Krytka Ø 18 mm	GC838180B004	127,- 154,-	5,4 6,5
POBR	Krytka Ø 22 mm	GC838220B004	150,- 181,-	6,4 7,6
ZLATÁ	Krytka Ø 16 mm plast	GC838150JO04	57,- 69,-	2,4 2,9
ZLATÁ	Krytka Ø 18 mm plast	GC838170JO02	86,- 104,-	3,6 4,4
ZLATÁ	Krytka Ø 22 mm plast	GC838210JO02	108,- 131,-	4,6 5,5
BÍLÁ	Krytka Ø 16 mm plast	GC838160Y301	20,- 24,-	0,9 1,0
BÍLÁ	Krytka Ø 18 mm plast	GC838180Y303	20,- 24,-	0,9 1,0

Povrch	typ provedení	obj. číslo	CZK s DPH	EUR s DPH
BÍLÁ	Krytka Ø 22 mm plast	GC838220Y301	26,- 31,-	1,1 1,3
OC	Krytka Ø 15 mm plast	GC838150JI02	34,- 41,-	1,5 1,7
OC	Krytka Ø 18 mm plast	GC838180YB01	86,- 104,-	3,6 4,4
ONS	Krytka Ø 16 mm plast	GC838160YC01	105,- 127,-	4,5 5,4
ONS	Krytka Ø 18 mm plast	GC838180YC01	144,- 175,-	6,1 7,4
ONS	Krytka Ø 22 mm plast	GC838220YC01	170,- 206,-	7,2 8,7
F4	Krytka Ø 16 mm plast	GC838150JZ02	71,- 85,-	3,0 3,6
F4	Krytka Ø 18 mm plast	GC838170JZ02	73,- 88,-	3,1 3,7
F4	Krytka Ø 22 mm plast	GC838210JZ02	91,- 110,-	3,9 4,6

Závěs 530



Povrch	typ provedení	obj. číslo	CZK s DPH	EUR s DPH
POMOS	Závěs 530 9 mm horní	CF530090O004	4,- 5,-	0,2 0,2
POMOS	Závěs 530 9 mm spodní	CG530090O006	5,- 6,-	0,2 0,3
ŽL. POZ	Závěs 530 9 mm horní	CF530090H102	3,- 4,-	0,1 0,2
ŽL. POZ	Závěs 530 9 mm spodní	CG530090H102	4,- 5,-	0,2 0,2
POBR	Závěs 530 9 mm horní	CF530090BN08	4,- 5,-	0,2 0,2
POBR	Závěs 530 9 mm spodní	CG530090BN14	5,- 6,-	0,2 0,3
POZINK	Závěs 530 9 mm horní	CF530090H008	3,- 4,-	0,1 0,2
POZINK	Závěs 530 9 mm spodní	CG530090H008	4,- 5,-	0,2 0,2
PONIKL	Závěs 530 9 mm horní	CF530090N002	3,- 4,-	0,1 0,2
PONIKL	Závěs 530 9 mm spodní	CG530090N002	4,- 5,-	0,2 0,2
POMOS	Závěs 530 11 mm horní	CF530110O002	5,- 6,-	0,2 0,3
POMOS	Závěs 530 11 mm spodní	CG530110O002	6,- 8,-	0,3 0,3
ŽL. POZ	Závěs 530 11 mm horní	CF530110H104	5,- 6,-	0,2 0,3
ŽL. POZ	Závěs 530 11 mm spodní	CG530110H104	5,- 6,-	0,2 0,3
POZINK	Závěs 530 11 mm horní	CF530110H006	4,- 5,-	0,2 0,2
POZINK	Závěs 530 11 mm spodní	CG530110H004	5,- 6,-	0,2 0,3

Závěs 605



Povrch	typ provedení	obj. číslo	CZK s DPH	EUR s DPH
POMOS	Závěs 605 9 mm horní	CF605090O006	6,- 8,-	0,3 0,3
POMOS	Závěs 605 9 mm spodní	CG605090O008	7,- 9,-	0,3 0,4
POBR	Závěs 605 9 mm horní	CF605090BN09	5,- 6,-	0,2 0,3
POBR	Závěs 605 9 mm spodní	CG605090BN15	6,- 8,-	0,3 0,3
BRONZ	Závěs 605 9 mm horní	CF605090B106	5,- 6,-	0,2 0,3
BRONZ	Závěs 605 9 mm spodní	CG605090B108	6,- 8,-	0,3 0,3
POMOS	Závěs 605 11 mm horní	CF605110O003	10,- 12,-	0,4 0,5
POMOS	Závěs 605 11 mm spodní	CG605110O003	11,- 13,-	0,5 0,5
POBR	Závěs 605 11 mm horní	CF605110BN03	10,- 12,-	0,4 0,5
POBR	Závěs 605 11 mm spodní	CG605110BN03	11,- 13,-	0,5 0,5
BRONZ	Závěs 605 11 mm horní	CF605110B105	10,- 12,-	0,4 0,5
BRONZ	Závěs 605 11 mm spodní	CG605110B107	11,- 13,-	0,5 0,5

Krytka ozdobná k závěsu 495



Povrch	typ provedení	obj. číslo	CZK s DPH	EUR s DPH
OLV	Krytka 16 mm	GC839160L103	112,- 136,-	4,8 5,7
OLV	Krytka 18 mm	GC839180L103	144,- 175,-	6,1 7,4
OLV	Krytka 22 mm	GC839220L103	268,- 324,-	11,4 13,7
POBR	Krytka 16 mm	GC839160BN03	107,- 129,-	4,6 5,5
POBR	Krytka 18 mm	GC839220L103	112,- 136,-	4,8 5,7
POBR	Krytka 22 mm	GC839220BN04	225,- 272,-	9,6 11,5

Záklopka dveří



- 15 -

Povrch	typ provedení	obj. číslo	CZK	s DPH	EUR	s DPH
POBR	Záklopka 160 mm	LC260160B002	75,-	91,-	3,2	3,8
POBR	Záklopka 200 mm	LC260200B002	80,-	97,-	3,4	4,1
POBR	Záklopka 250 mm	LC260250B002	85,-	103,-	3,6	4,3
POBR	Záklopka 300 mm	LC260300B002	85,-	103,-	3,6	4,3
POBR	Záklopka 400 mm	LC260400B002	110,-	133,-	4,7	5,6
POBR	Záklopka 500 mm	LC260500B002	120,-	145,-	5,1	6,1
POBR	Záklopka 600 mm	LC260600B002	180,-	218,-	7,7	9,2
POZINK	Záklopka 160 mm	LC260160H002	65,-	79,-	2,8	3,3
POZINK	Záklopka 200 mm	LC260200H002	54,-	65,-	2,3	2,8
POZINK	Záklopka 250 mm	LC260250H004	55,-	67,-	2,3	2,8
POZINK	Záklopka 300 mm	LC260300H002	60,-	73,-	2,6	3,1
POZINK	Záklopka 400 mm	LC260400H002	60,-	73,-	2,6	3,1
ŽL. POZ	Záklopka 160 mm	LC260160H102	65,-	79,-	2,8	3,3
ŽL. POZ	Záklopka 200 mm	LC260200H102	70,-	84,-	3,0	3,6
ŽL. POZ	Záklopka 250 mm	LC260250H102	80,-	97,-	3,4	4,1
ŽL. POZ	Záklopka 300 mm	LC260300H102	80,-	97,-	3,4	4,1
ŽL. POZ	Záklopka 400 mm	LC260400H102	85,-	103,-	3,6	4,3
POMOS	Záklopka 160 mm	LC260160O002	53,-	64,-	2,3	2,8
POMOS	Záklopka 200 mm	LC260200O002	70,-	84,-	3,0	3,6
POMOS	Záklopka 250 mm	LC260250O002	70,-	84,-	3,0	3,6
POMOS	Záklopka 300 mm	LC260300O002	80,-	97,-	3,4	4,1
POMOS	Záklopka 400 mm	LC260400O002	100,-	121,-	4,3	5,1
POMOS	Záklopka 500 mm	LC260500O002	110,-	133,-	4,7	5,6
POMOS	Záklopka 600 mm	LC260600O002	165,-	200,-	7,0	8,4
POMOS	Záklopka 800 mm	LC260800O002	310,-	375,-	13,2	15,8
PONIKL	Záklopka 160 mm	LC260160N006	65,-	79,-	2,8	3,4

Závěs kyvných dveří



- 96, 133 -

Povrch	typ provedení	obj. číslo	CZK	s DPH	EUR	s DPH
OF	Závěs 100 mm	21179020P	487,-	589,-	20,7	24,9
OLV	Závěs 100 mm	21179000P	599,-	725,-	25,5	30,6
PONIKL	Závěs 100 mm	21179010P	487,-	589,-	20,7	24,9
OF	Závěs 125 mm	21179120P	631,-	764,-	26,9	32,2
OLV	Závěs 125 mm	21179100P	631,-	764,-	26,9	32,2
PONIKL	Závěs 125 mm	21179110P	631,-	764,-	26,9	32,2
OF	Závěs 150 mm	21179220P	867,-	1049,-	36,9	44,3
OLV	Závěs 150 mm	21179200P	867,-	1049,-	36,9	44,3
PONIKL	Závěs 150 mm	21179210P	867,-	1049,-	36,9	44,3

Povrch	typ provedení	obj. číslo	CZK	s DPH	EUR	s DPH
F1	Závěs 180x96 mm	7J5904F1	1541,-	1864,-	65,6	78,7
F4	Závěs 180x96 mm	7J5904F4	1616,-	1955,-	68,8	82,5
F1	Závěs 180x133 mm	7J5914F1	1434,-	1735,-	61,0	73,2
F4	Závěs 180x133 mm	7J5914F4	1493,-	1806,-	63,5	76,2
BIĽÁ	Závěs 180x133 mm	7J5914PX	1493,-	1806,-	63,5	76,2

Závěs kovaný

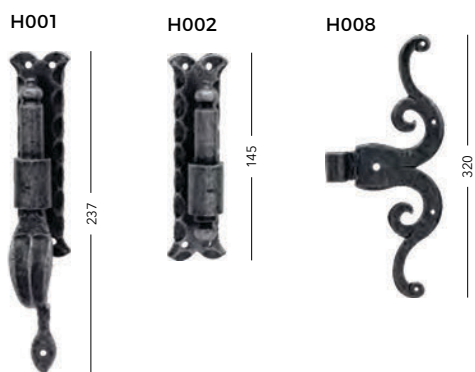

Povrch	typ provedení	obj. číslo	CZK	s DPH	EUR	s DPH
K	Závěs H001 23 cm dolní	HA129X001	1257,-	1521,-	53,5	64,2
K	Závěs H002 14,5 cm dolní	HA129X002	1000,-	1211,-	42,6	51,1
K	Závěs H008 32 cm horní	HA127X008	1049,-	1269,-	44,6	53,5
K	Závěs H011 42 cm horní	HA127X011	1107,-	1340,-	47,1	56,6
K	Závěs H025 39 cm horní	HA127X025	1295,-	1567,-	55,1	66,1
K	Závěs H027 60 cm horní	HA127X027	1241,-	1502,-	52,8	63,4

H011



425

H025



395

H027



600

POPRODEJNÍ SERVIS, ZÁRUKY, MONTÁŽ A ÚDRŽBA

COBRA ručí za spolehlivé fungování. Prodejem naše péče o zákazníky nekončí. Pečlivě a systematicky rozvíjíme a podporujeme síť našich partnerů, kteří jsou díky tomu vždy připraveni poskytnout Vám poprodejní služby spojené s údržbou našich výrobků nebo s dodávkou náhradních dílů.



ZÁRUKY

Za naše výrobky a služby ručíme. Na naše výrobky poskytujeme záruky v rozsahu od dvou do deseti let. Na kliky COBRA se můžete spolehnout.

ZÁRUKA AŽ 10 LET

Na vybrané kování COBRA poskytujeme záruku až 5 let, na designové kování CONVEX až 10 let.

MONTÁŽ & ÚDRŽBA

Montáž klik provádíme vždy podle příbalového letáku a doporučujeme použít naši montážní šablonu. Aby Vám výrobky COBRA dlouho sloužily, doporučujeme jejich pravidelnou kontrolu, údržbu a čištění. Údržba klik není nijak náročná, spočívá především v kontrole stavu a kvality. Každého půl roku provedeme utažení všech spojovacích šroubů. Mechanismus promažeme vazelínou.

Můžete se setkat s mechanickým poškozením způsobeným hrubým nebo neopatrným zacházením. V takovém případě se obraťte na některého z našich partnerů, který Vám ochotně a profesionálně poradí, jak se s poškozením vypořádat. Do opravy kování sami nezasahujeme, vždy se raději poraďte s odborníkem.

Díky tradici a dostupnosti výrobků COBRA se dá očekávat, že Váš zvolený model kliky bude ještě dlouho dostupný. Pro čištění od prachu, nebo jiných nečistot použijte suchý nebo ve vodě navlhčený jemný hadřík. Nepoužívejte brusné a chemické přípravky. Při použití chemických prostředků hrozí oxidace materiálů, a tudíž poškození výrobku. Nerezové kování splňuje nejvyšší nároky odolnosti proti mechanickému poškození a při jeho údržbě lze použít i vhodné čisticí přípravky. Jeho montáž doporučujeme v provozech, které musí splňovat hygienické podmínky.

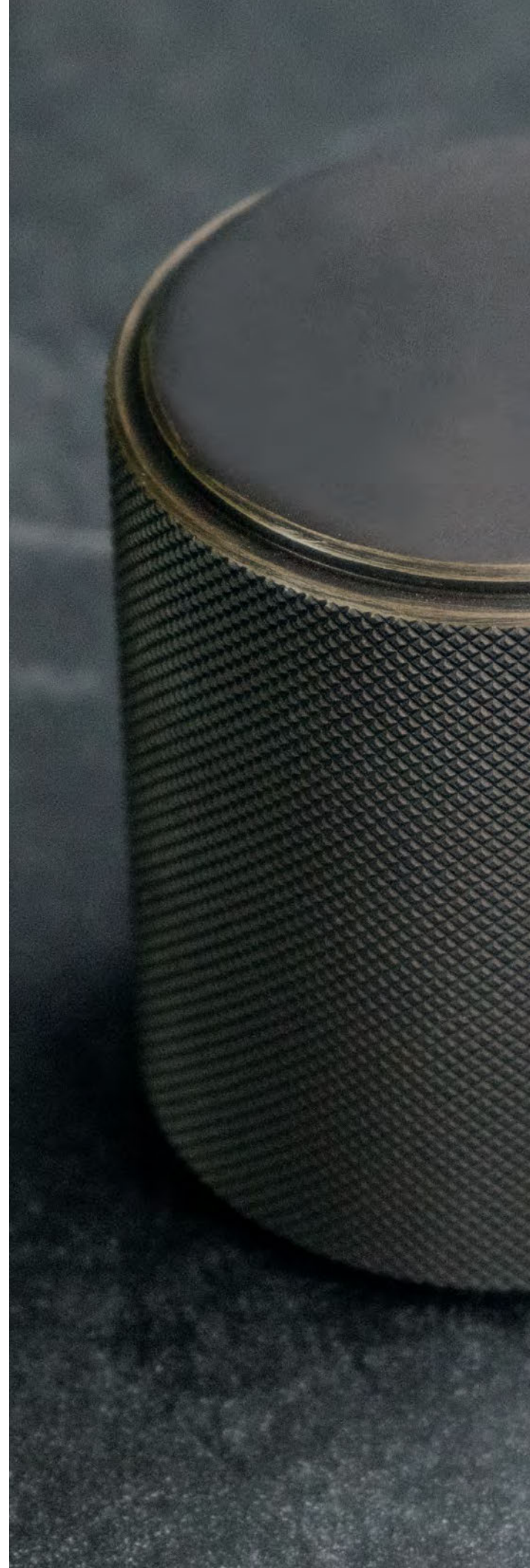

AFTER SALES SERVICE, GUARANTEES. MOUNTING AND MAINTENANCE

COBRA guarantees reliable functioning. Selling our product does not mean the end of our customer care. We carefully and systematically develop and support network of our business partners who are thus ready to provide you with after sales services related to our products' maintenance as well as with the delivery of spare parts.

GUARANTEES

Our products and services are guaranteed. We provide guarantees on our products ranging from two to ten years. COBRA handles can be relied on.

GUARANTEE UP TO 10 YEARS

We provide a guarantee up to 5 years for selected COBRA fittings and up to 10 years for a design CONVEX fitting.

MOUNTING & MAINTENANCE

Mounting of the fitting is always carried out in accordance with the package leaflet. We would also like to advise you to use our mounting template if possible. In order to gain the best performance of all COBRA products, their regular checking, maintenance and cleaning is strongly recommended.

The maintenance of handles is not a demanding job to do, it basically consists of checking the quality and condition. Every six months all the fastening screws are tightened and the entire mechanism is greased with petroleum jelly. You can also encounter some mechanical damage caused by careless or rough handling. In that case feel free to contact any of our business partners who will provide you with a professional advice on how to handle the whole issue. It is advisable not to try to fix the fitting by yourselves and consult the matter with an expert.

Thanks to a long tradition and availability of COBRA products it can be expected that the particular type of handle which you have chosen is going to be available for many years to come. In order to remove dust or any other impurities off the handle dry or fine damp piece of cloth is recommended to be used. Do not use any abrasive or chemical products. If any chemical product is used, it may result in oxidation of the material and subsequent damage of the product.

Stainless fitting meets the highest standards for durability and resistance against mechanical damage. During its maintenance any suitable detergent can be used. We strongly recommend to mount our products in places where complying with health conditions is a crucial point.

PREMIUM

Infinity
Spectra
Ultima
Kanelaz 1745

IN

Nerez Classic

Alena-S
Bianca-R
Giussy-R
Giussy-S
Giussy
Loft-R
Loft-R ovál
Loft
Nova-S
Paola

Paola-R
Pavla-S
Pavla-H
Plaza
Plaza-R
Plaza-S
Plaza-H
Sali
Sali-R
Sali-S

Ufo
Ufo Slim
Ufo-R
Ufo-R ovál
Vision-S
Vision
Vision-R
Vision-R ovál
Vision-R plochá rozeta
Vision-S plochá rozeta

Zoe-R
Koule pevná Luna
Koule pevná Star
Koule pevná Stella

IN

Nerez Economy

Diva-R III
Giussy-R III
Giussy-S III
Iris-R
Iris-S

Loft-R III
Paola-R III
Pavla-R III
Pavla-S III
Sali-R III

Ufo-R III
Vision-R III
Vision-S III

IN

Nerez Project

LOFT
LOFT-kratký štít
LOFT-OVÁL
LOFT-R

UFO
UFO-kratký štít
UFO-OVÁL
UFO-R

VISION
VISION-kratký štít
VISION-OVÁL
VISION-R

OCS

Chrom matný

Alexis-R
Alt-wien
Elegant
Elsa-S
Esme-S
Spring-S
Jerome-S
Laura

Laura-R
Mega-R
Mega-S
Milena
Milena-R
Orion
Orion-R
Presso-S

Q-arte
Q-arte-S
865
1145
1485
1495
1505
1515

1535
1555
Koule pevná Victory

OC

Chrom lesklý

Alt-wien
Elegant
Laura
Laura-R
Orion-R
1485

1495
1505
1515

ONS

Nikl matný

Alexis
Alexis-R
Alt-wien
Aphrodité-S
Athena-S
Beata-S
Denisa
Denisa-R
Elegant
Element
Element-R

Elsa-S
Esme-S
Fap
Fap-R
Laura
Laura-R
Maja
Milena
Milena-R
Orion
Orion-R

Orion-R III
Presso-S
Q-arte
Q-arte-S
Sina
Sina-R
Spring-S
Vega-S
Vera-S
Zeus
Zeus-R III

Zoe-R
865
1145
1495
1535
1555
Koule pevná Victory

ČERNÁ/TITAN

Černá/titan

Aphrodité-S
Athena-S
Linda-S
Vega-S
Vera-S
Vision-R III

Zoe-R
865
1555

OCN

Chrom lesk. / Nikl matný

Gabri
Gabri-R
Gabri-S
Giussy-R
Nicol-R
Nicol-S

Sharon-R
Sharon-S
Vanda-R
Koule pevná Victory

OFS

Bronz česaný

Alt-wien
Atlantis
Dea
Dea-R
Elegant
Florence

Giussy-R
Ikarus
Kristina
Kristina-R
Laura
Laura-R

Milena
Munster
Sina
Sina-R
Venezia
Vera-S

Zoe-R
Koule pevná Victory

OLV Mosaz leštěná	Alt-wien Atlantis Elegant	Ikarus Kristina Kristina-R	Laura Laura-R Munster	
OV Staromosaz	Alt-wien Elegant			
K Kované a rustikální kování	Alt-wien Atlantis Atlantis-R Baden Baden+ Baden-S Baden-S+ Berlin	Bremen Burg Burg-R Elegant Hamburg Hamburg-R Hamburg-R+	Imst+ Imst-R Innsbruck Innsbruck-R Regen Salzburg Salzburg-S Venezia	Venezia-R Vienna-R+ Koule pevná Bonn HR Koule pevná Linz HR
BK Bezpečnostní a ochranné kování	Alt-wien Alt-wien+ Apollo+ C101+ C201 C301 C501+	Diana-R+ Elegant Elegant+ Mars-S+ Rozeta Tower Slim-2 Sveva	Sveva+ Titan Titan+ Tower Tower+ Tower-H Tower-H+	Přídavná rozeta hranatá Přídavná rozeta kulatá Přídavná rozeta oválná
S Sety	Set Alt-wien Set Hliník Set Vision			
F1 Stříbrný elox	Monet Monet-R	Universal Universal-R		
F4 Bronzový elox	Monet Monet-R	Universal Universal-R		
OKENNÍ KOVÁNÍ	Alt-wien Elegant	F1 F4	kované Vision	
MADLA / ÚCHYTY	Madla Inox Madla Madlo Bregenz Madlo Stein Madla na míru	Posuvný systém Náprstky MQ Náprstky MT Náprstek Essen Úchyt 3663	Úchyt 3665 Úchyt 3666 Kulatá Úchyt 3667 Hranatá Úchyty Úchyty	Úchytky kované 001 Úchytky kované 003 Úchytky kované 004 Úchytky Ulmen Úchytky Nurnberg
DOPLŇKY	Balkónové kliky Kovaná posuvná klika Steinacht Cylindrické vložky Číslice a piktogramy / klepadla	Dorazy, stavěče, zárážky Řetízky, kukátka Držáky zábradlí Drobný spojovací materiál	Krbové nářadí / Dětský program Panikové kování Rozety / montážní šablony Prahové lišty Samozavírače	Větrací mřížky Vhozy na dopisy Věšáky a konzole Zadlabací zámky Závěsy

